

2016

TRAUMA CATALOG

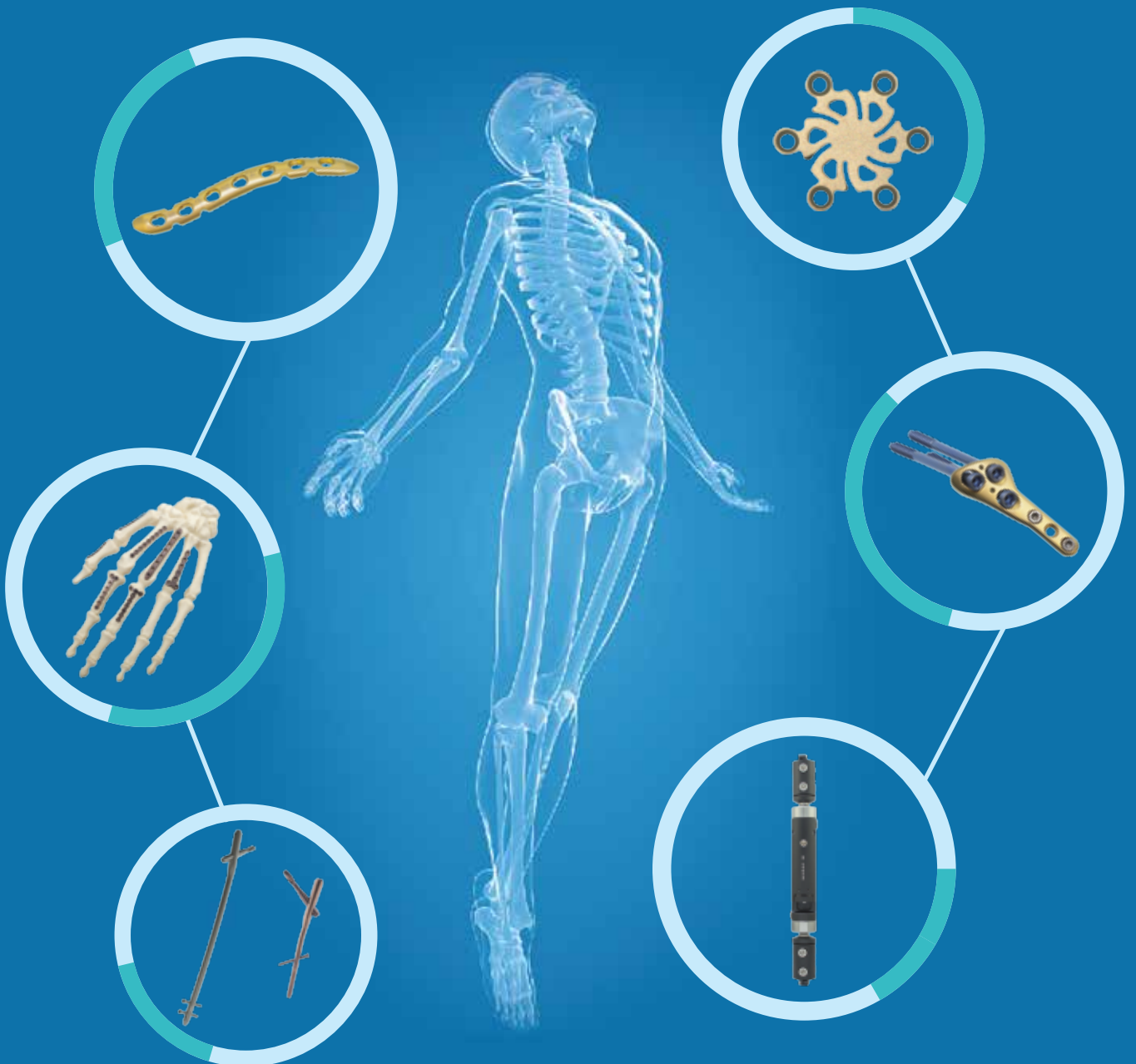

TRAUMA CATALOG 2016

01. MonoLoc 1.5/2.0 System	1
02. MonoLoc LCP System	27
03. DHS & DCS System	77
04. Screws & Washers System	86
05. KCS & HCS System	95
06. NeoGen Nails System	114
07. External Fixator System	148
08. Synplate Conventional Plates System	176
09. Wires & Pins System	208
10. Cranial Maxillofacial System	210

MonoLoc Locking Plates System

- MonoLoc Locking Plates 1.5/2.0 System
- MonoLoc Locking Plates 2.4/2.7 System





MonoLoc Locking Plates 1.5/2.0mm System



Locking Plate 1.5, straight



Product No.	Size	Material	Model No.
29476504	4H	PT	SDXZ40
29476506	6H	PT	SDXZ40

Locking Reconstruction Plate 1.5



Product No.	Size	Material	Model No.
29476006	6H	PT	SDXZ75
29476012	12H	PT	SDXZ75

Locking T-Plate 1.5



Product No.	Size	Material	Model No.
29476608	3+8H	PT	SDXZ73
29476408	4+8H	PT	SDXZ74

Locking Y-Plate 1.5



Product No.	Size	Material	Model No.
29478308	3+8H	PT	SDXZ06

Locking Condylar Plate 1.5



Product No.	Size	Material	Model No.
29475906	2+6H	PT	SDXZ45

Locking Strut Plate 1.5



Product No.	Material	Model No.
24241000	PT	SDXZ68



Locking Plate 2.0, straight



Product No.	Size	Material	Model No.
29475404	4H	PT	SDXZ40
29475405	5H	PT	SDXZ40
29475406	6H	PT	SDXZ40
29475407	7H	PT	SDXZ40
29475408	8H	PT	SDXZ40

Locking T-Plate 2.0



Product No.	Size	Material	Model No.
29476107	3+7H	PT	SDXZ73

Locking Condylar Plate 2.0



Product No.	Size	Material	Model No.
29475307	2+7H	PT	SDXZ45

Locking Y-adaption Plate 2.0



Product No.	Size	Material	Model No.
29476307	3+7H	PT	SDXZ06

Locking T-adaption Plate 2.0



Product No.	Size	Material	Model No.
29476207	2+7H	PT	SDXZ72

Rotation Correction Locking Plate 2.0



Product No.	Material	Model No.
24242000	PT	SDXG78

Mini Condylar Locking Plate 2.0



Product No.	Direction	Material	Model No.
24243200	Left	PT	SDXG46
24243100	Right	PT	SDXG47

Mini H Locking Plate 2.0



Product No.	Material	Model No.
24244000	PT	SDXZ70



1.5mm Locking Screw Stardrive, self-tapping



Product No.	Size	Material	Model No.
39475806	6mm	TA	SDLD01
39475808	8mm	TA	SDLD01
39475810	10mm	TA	SDLD01
39475812	12mm	TA	SDLD01
39475814	14mm	TA	SDLD01
39475816	16mm	TA	SDLD01
39475818	18mm	TA	SDLD01
39475820	20mm	TA	SDLD01
39475822	22mm	TA	SDLD01
39475824	24mm	TA	SDLD01

1.5mm Cortex Screw Stardrive, self-tapping



Product No.	Size	Material	Model No.
39475706	6mm	TA	SSQ01
39475708	8mm	TA	SSQ01
39475710	10mm	TA	SSQ01
39475712	12mm	TA	SSQ01
39475714	14mm	TA	SSQ01
39475716	16mm	TA	SSQ01
39475718	18mm	TA	SSQ01
39475720	20mm	TA	SSQ01
39475722	22mm	TA	SSQ01
39475724	24mm	TA	SSQ01

2.0mm Locking Screw Stardrive, self-tapping



Product No.	Size	Material	Model No.
39475606	6mm	TA	SDLD01
39475608	8mm	TA	SDLD01
39475610	10mm	TA	SDLD01
39475612	12mm	TA	SDLD01
39475614	14mm	TA	SDLD01
39475616	16mm	TA	SDLD01
39475618	18mm	TA	SDLD01
39475620	20mm	TA	SDLD01
39475622	22mm	TA	SDLD01
39475624	24mm	TA	SDLD01
39475626	26mm	TA	SDLD01
39475628	28mm	TA	SDLD01
39475630	30mm	TA	SDLD01

2.0mm Cortex Screw Stardrive, self-tapping



Product No.	Size	Material	Model No.
39475506	6mm	TA	SSQ01
39475508	8mm	TA	SSQ01
39475510	10mm	TA	SSQ01
39475512	12mm	TA	SSQ01
39475514	14mm	TA	SSQ01
39475516	16mm	TA	SSQ01
39475518	18mm	TA	SSQ01
39475520	20mm	TA	SSQ01
39475522	22mm	TA	SSQ01
39475524	24mm	TA	SSQ01
39475526	26mm	TA	SSQ01
39475528	28mm	TA	SSQ01
39475530	30mm	TA	SSQ01
39475532	32mm	TA	SSQ01
39475534	34mm	TA	SSQ01
39475538	38mm	TA	SSQ01

MonoLoc Locking Plates 2.4/2.7mm System



Locking Plate 2.4, Straight



Product No.	Size	Material	Model No.
24201004	4H	PT	SDXZ40
24201005	5H	PT	SDXZ40
24201006	6H	PT	SDXZ40
24201007	7H	PT	SDXZ40
24201008	8H	PT	SDXZ40
24201010	10H	PT	SDXZ40

Locking Condylar Plate 2.4



Product No.	Size	Material	Model No.
24202000	2+7H	PT	SDXZ45

Locking Y-Plate 2.4



Product No.	Size	Material	Model No.
24203000	3+7H	PT	SDXZ06

Locking T-Plate 2.4



Product No.	Size	Material	Model No.
24204000	2+7H	PT	SDXZ72
24205000	3+7H	PT	SDXZ73

Locking Plate 2.7, Straight



Product No.	Size	Material	Model No.
24206004	4H	PT	SDXZ40
24206005	5H	PT	SDXZ40
24206006	6H	PT	SDXZ40
24206007	7H	PT	SDXZ40
24206008	8H	PT	SDXZ40
24206009	9H	PT	SDXZ40
24201010	10H	PT	SDXZ40

Locking Condylar Plate 2.7



Product No.	Size	Material	Model No.
24207000	2+7H	PT	SDXZ45



Locking T-Plate 2.7



Product No.	Size	Material	Model No.
24208000	2+3H	PT	SDXZ72

Locking L-Plate 2.7



Product No.	Size	Direction	Material	Model No.
24209200	2+3H	Left	PT	SDXZ76
24209100	2+3H	Right	PT	SDXZ77

Locking L-Plate 2.7, Oblique



Product No.	Size	Direction	Material	Model No.
24210200	2+3H	Left	PT	SDXZ57
24210100	2+3H	Right	PT	SDXZ58

X Locking Plate



Product No.	Size	Material	Model No.
24211001	Large	PT	SDXZ70
24211002	Medium	PT	SDXZ70
24211003	Small	PT	SDXZ70

2-Hole Locking Plate



Product No.	Size	Material	Model No.
24235000	2H	PT	SDXZ75

2.7mm Locking Screw, Self tapping



Product No.	Size	Material	Model No.
32580006	6mm	TA	SDLD01
32580007	7mm	TA	SDLD01
32580008	8mm	TA	SDLD01
32580009	9mm	TA	SDLD01
32580010	10mm	TA	SDLD01
32580011	11mm	TA	SDLD01
32580012	12mm	TA	SDLD01
32580013	13mm	TA	SDLD01
32580014	14mm	TA	SDLD01
32580016	16mm	TA	SDLD01
32580018	18mm	TA	SDLD01
32580020	20mm	TA	SDLD01
32580022	22mm	TA	SDLD01
32580024	24mm	TA	SDLD01
32580026	26mm	TA	SDLD01
32580028	28mm	TA	SDLD01
32580030	30mm	TA	SDLD01
32580032	32mm	TA	SDLD01
32580034	34mm	TA	SDLD01
32580036	36mm	TA	SDLD01
32580038	38mm	TA	SDLD01
32580040	40mm	TA	SDLD01
32580042	42mm	TA	SDLD01
32580044	44mm	TA	SDLD01
32580046	46mm	TA	SDLD01
32580048	48mm	TA	SDLD01
32580050	50mm	TA	SDLD01
32580052	52mm	TA	SDLD01
32580054	54mm	TA	SDLD01
32580056	56mm	TA	SDLD01
32580058	58mm	TA	SDLD01
32580060	60mm	TA	SDLD01

2.7mm Cortex Screw, Self tapping



Product No.	Size	Material	Model No.
30375006	6mm	TA	HAQ06
30375007	7mm	TA	HAQ06
30375008	8mm	TA	HAQ06
30375009	9mm	TA	HAQ06
30375010	10mm	TA	HAQ06
30375011	11mm	TA	HAQ06
30375012	12mm	TA	HAQ06
30375013	13mm	TA	HAQ06
30375014	14mm	TA	HAQ06
30375016	16mm	TA	HAQ06
30375018	18mm	TA	HAQ06
30375020	20mm	TA	HAQ06
30375022	22mm	TA	HAQ06
30375024	24mm	TA	HAQ06
30375026	26mm	TA	HAQ06
30375028	28mm	TA	HAQ06
30375030	30mm	TA	HAQ06
30375032	32mm	TA	HAQ06
30375034	34mm	TA	HAQ06
30375036	36mm	TA	HAQ06
30375038	38mm	TA	HAQ06
30375040	40mm	TA	HAQ06
30375042	42mm	TA	HAQ06
30375044	44mm	TA	HAQ06
30375046	46mm	TA	HAQ06
30375048	48mm	TA	HAQ06
30375050	50mm	TA	HAQ06
30375052	52mm	TA	HAQ06
30375054	54mm	TA	HAQ06
30375056	56mm	TA	HAQ06
30375058	58mm	TA	HAQ06
30375060	60mm	TA	HAQ06



2.4mm Locking Screw, Self tapping



Product No.	Size	Material	Model No.
34217006	6mm	TA	SDLD01
34217007	7mm	TA	SDLD01
34217008	8mm	TA	SDLD01
34217009	9mm	TA	SDLD01
34217010	10mm	TA	SDLD01
34217011	11mm	TA	SDLD01
34217012	12mm	TA	SDLD01
34217013	13mm	TA	SDLD01
34217014	14mm	TA	SDLD01
34217016	16mm	TA	SDLD01
34217018	18mm	TA	SDLD01
34217020	20mm	TA	SDLD01
34217022	22mm	TA	SDLD01
34217024	24mm	TA	SDLD01
34217026	26mm	TA	SDLD01
34217028	28mm	TA	SDLD01
34217030	30mm	TA	SDLD01

2.4mm Cortex Screw, Self tapping



Product No.	Size	Material	Model No.
30374006	6mm	TA	HAQ06
30374007	7mm	TA	HAQ06
30374008	8mm	TA	HAQ06
30374009	9mm	TA	HAQ06
30374010	10mm	TA	HAQ06
30374011	11mm	TA	HAQ06
30374012	12mm	TA	HAQ06
30374013	13mm	TA	HAQ06
30374014	14mm	TA	HAQ06
30374016	16mm	TA	HAQ06
30374018	18mm	TA	HAQ06
30374020	20mm	TA	HAQ06
30374022	22mm	TA	HAQ06
30374024	24mm	TA	HAQ06
30374026	26mm	TA	HAQ06
30374028	28mm	TA	HAQ06
30374030	30mm	TA	HAQ06
30374032	32mm	TA	HAQ06
30374034	34mm	TA	HAQ06
30374036	36mm	TA	HAQ06
30374038	38mm	TA	HAQ06
30374040	40mm	TA	HAQ06
30374042	42mm	TA	HAQ06
30374044	44mm	TA	HAQ06
30374046	46mm	TA	HAQ06
30374048	48mm	TA	HAQ06
30374050	50mm	TA	HAQ06
30374052	52mm	TA	HAQ06
30374054	54mm	TA	HAQ06
30374056	56mm	TA	HAQ06
30374058	58mm	TA	HAQ06
30374060	60mm	TA	HAQ06



1.8mm Buttress Pin



Product No.	Size	Material	Model No.
32581010	10mm	TA	SDLD04
32581012	12mm	TA	SDLD04
32581014	14mm	TA	SDLD04
32581016	16mm	TA	SDLD04
32581018	18mm	TA	SDLD04
32581020	20mm	TA	SDLD04
32581022	22mm	TA	SDLD04
32581024	24mm	TA	SDLD04
32581026	26mm	TA	SDLD04
32581028	28mm	TA	SDLD04
32581030	30mm	TA	SDLD04

MonoLoc Locking Plates 1.5/2.0mm System Instruments Set

Code	Product Description	Qty
98370	Monoloc Locking Plates 1.5/2.0mm Instruments Set	
898345	Monoloc Locking Plates 1.5/2.0mm Instruments Set (empty)-PPSU	1
216100	Handle, with Mini Quick Coupling	2
217490	Bending-Cutting Pliers	1
217500	Universal Pliers, pointed, for Plates 1.0 to 2.0 (left)	1
217510	Universal Pliers, pointed, for Plates 1.0 to 2.0 (right)	1
01123	Reduction Forceps with Points	1
01215	Retractor, width 6mm	1
01216	Retractor, width 8mm	1
01217	Retractor, width 15mm	1
01218	Sharp Hook	1
01219	Periosteal Elevator, width 5mm	1
01232	Periosteal Elevator, width 3mm	1
217530	Holding Forceps for Cortex Screws Φ 1.0 to 2.0mm	1
216180	Plate Holding Instruments, for Plates 2.0	1
216190	Plate Holding Instruments, for Plates 2.0	1
98567	Holding Forceps for Finger plates, ratchet lock	1
98086	Depth Gauge for Screws Φ 1.5 mm, measuring range up to 24 mm	1
98087	Depth Gauge for Screw Φ 2.0 mm, measuring range up to 40 mm	1
161210	Cutter	1

1.5mm implants tray (with instruments only)

Code	Product Description	Qty
98372	1.5mm implants tray	1
98091	Drill Bit Φ 1.1mm, with Quick Coupling	2
98085	Drill Bit Φ 1.5mm, with Quick Coupling	2
98080	Countersink for Screws Φ 1.3 and 1.5mm	1
98083	Double Drill Guide 1.5/1.1	1
98094	LCP Drill Sleeve 1.5, for Drill Bits Φ 1.1 mm	2
98100	Screwdriver Shaft Stardrive 1.5,T4,self-holding, with Quick Coupling	2
98098	Holding Sleeve 1.5	1
98092	Bending Pin for LCP Plates 1.5, with thread	2



2.0mm implants tray (with instruments only)

Code	Product Description	Qty
98373	2.0mm implants tray	1
98085	Drill Bit Φ 1.5mm, with Quick Coupling	2
98082	Drill Bit Φ 2.0mm, with Quick Coupling	2
98093	Countersink 1.5 to 2.4, with Quick Coupling	1
98095	Double Drill Guide 2.0/1.5 for Drill Bits 2.0 and 1.5mm	1
98096	LCP Drill Sleeve 2.0, with Scale, for Drill Bits Φ 1.5 mm	2
98099	Screwdriver Shaft Stardrive 2.0, with Quick Coupling	2
98097	Holding Sleeve 2.0	1
98081	Bending Pin for LCP Plates 2.0	2

Please contact your sales representative for final product list.



Monoloc Locking Plates 1.5/2.0mm Instruments Set

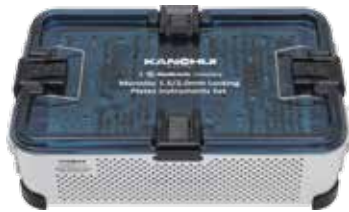

98370

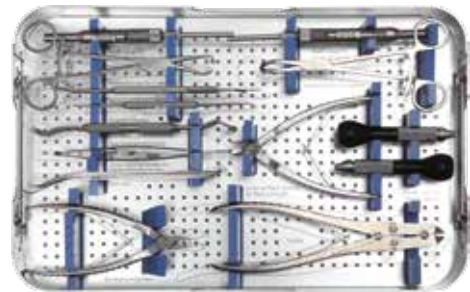

98372

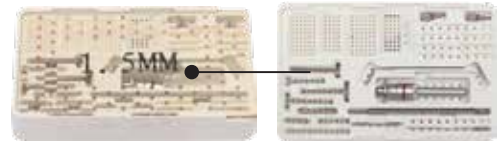

98373

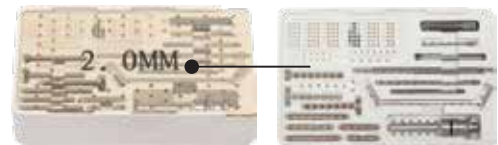

Instruments

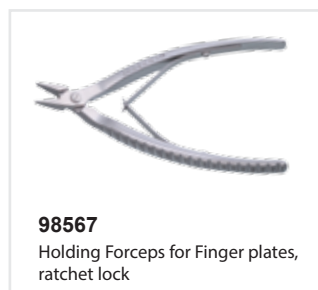
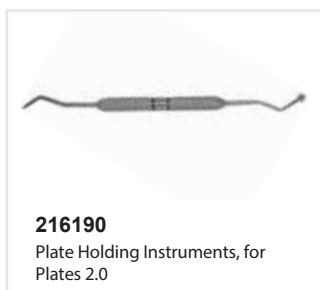
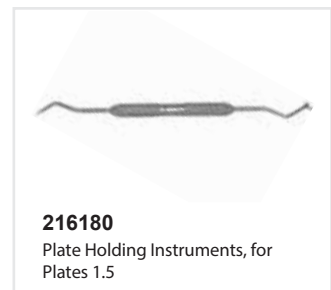
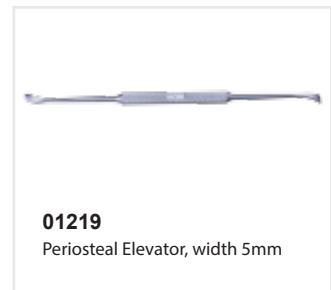
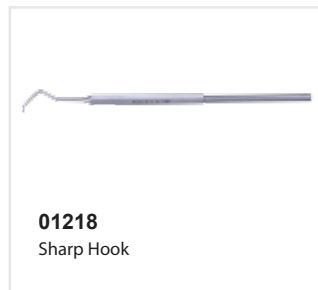
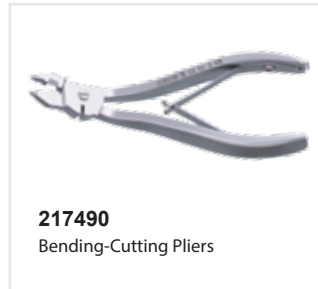



98087
Depth Gauge for Screw Φ 2.0 mm,
measuring range up to 40 mm



161210
Cutter



98091
Drill Bit Φ 1.1mm, with Quick
Coupling



98085
Drill Bit Φ 1.5mm, with Quick
Coupling



98080
Countersink for Screws Φ 1.3 and 1.5
mm



98083
Double Drill Guide 1.5/1.1



98094
LCP Drill Sleeve 1.5,
for Drill Bits Φ 1.1 mm



98100
Screwdriver Shaft Stardrive 1.5,T4,
self-holding, with Quick Coupling



98098
Holding Sleeve 1.5

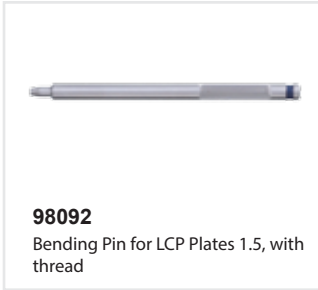

98092
Bending Pin for LCP Plates 1.5, with
thread



98085
Drill Bit Φ 1.5 mm, with Quick
Coupling



98082
Drill Bit Φ 2.0 mm, with Quick
Coupling



98093
Countersink 1.5 to 2.4, with Quick
Coupling



98095
Double Drill Guide 2.0/1.5 for Drill
Bits 2.0 and 1.5 mm



98096
LCP Drill Sleeve 2.0, with Scale, for
Drill Bits Φ 1.5 mm



98099
Screwdriver Shaft Stardrive 2.0, with
Quick Coupling



98097
Holding Sleeve 2.0



98081
Bending Pin for LCP Plates 2.0

MonoLoc Locking Plates 2.4/2.7mm System Instruments Set

Code	Product Description	Qty
288000	MonoLoc Locking Plates 2.4/2.7mm System Instruments Set	1
288050	Monoloc Locking Plates 2.4/2.7mm System Instrument Set (empty)	1
030100	T-Handle with Quick Coupling	2
288100	Bending-Cutting Pliers	2
01123	Reduction Forceps, with Points	1
01124	Reduction Forceps with Points, toothed	1
01215	Retractor, width 6mm	1
01216	Retractor, width 8mm	1
01217	Retractor, width 15mm	1
01218	Sharp Hook	1
01219	Periosteal Elevator, width 5mm	1
01232	Periosteal Elevator, width 3mm	1
216160	Plate Holder	1
288110	Bending Pin 2.4/2.7	4
286200	Depth Gauge, 60mm	1
288120	Easyout	1
288160	Locking Screw Holding Sleeve	1
288170	Cortex Screw Holding Sleeve	1
288130	Torx Screwdriver, with Quick Coupling, T8	2
286300	Countersink	1
288140	Screwdriver for Screw Removal, T8	1
288150	Torque-limiting Screwdriver, T8	1
10735150	K-wire, Φ 1.8×150mm	3

288020 2.4 mm Implants Tray (with Special Instruments)

Code	Product Description	Qty
288070	2.4 mm Implants Tray(empty)	1
286220	Drill Guide 1.8	2
286230	Drill Bit, Φ 1.8mm	2
286270	Drill Bit, Φ 2.4mm	2
286250	Double Drill Guide, 2.4/1.8	1
286290	Tap, Φ 2.4mm	2



288030 2.7 mm Implants Tray (with Special Instruments)

Code	Product Description	Qty
288080	2.7 mm Implants Tray(empty)	1
286120	Drill Guide 2.0	2
286130	Drill Bit, Φ 2.0mm	2
286260	Drill Bit, Φ 2.7mm	2
286240	Double Drill Guide , 2.7/2.0	1
286280	Tap, Φ 2.7mm	2

Please contact your sales representative for final product list.



MonoLoc Locking Plates 2.4/2.7mm System Instruments Set

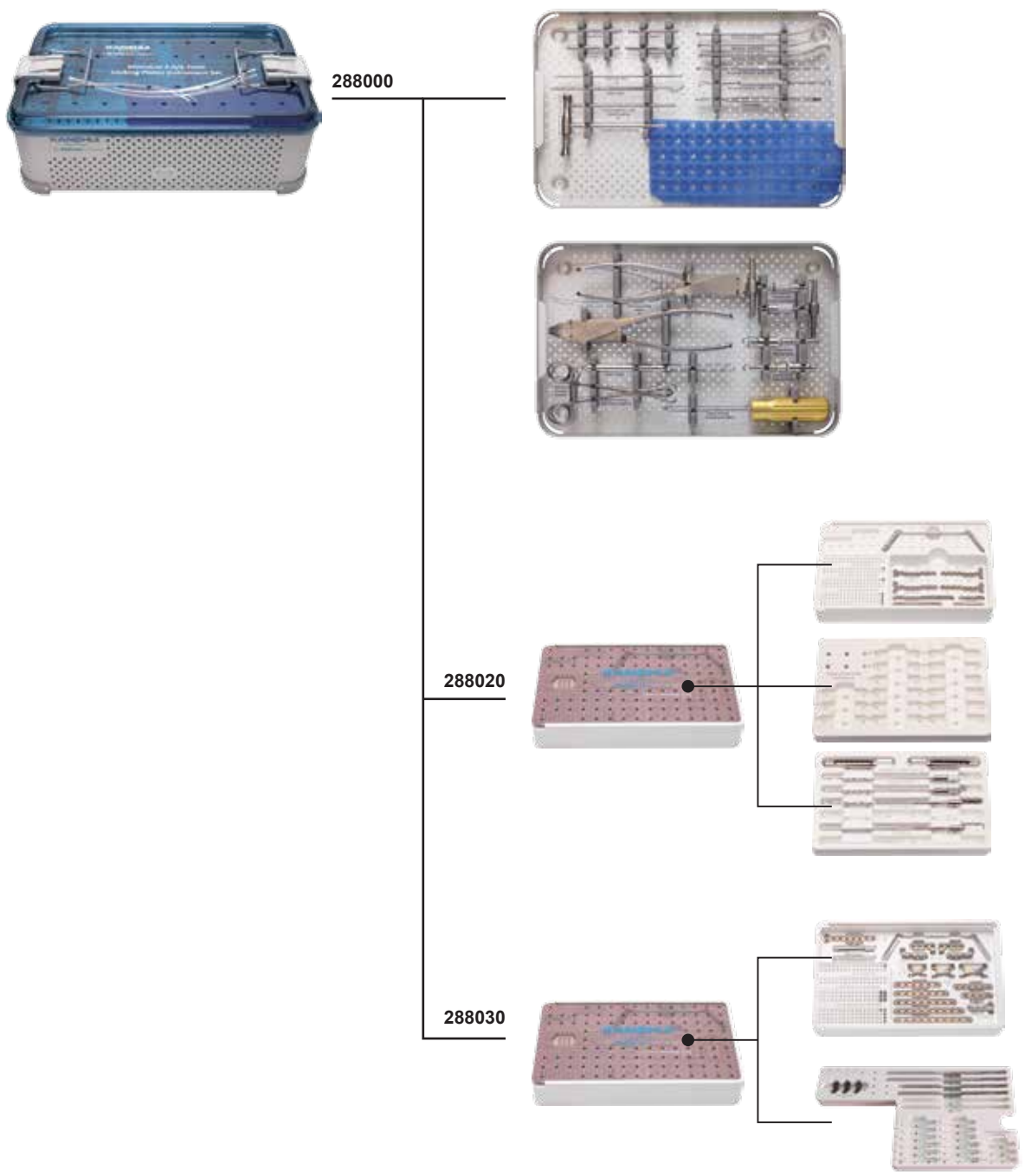

Instruments

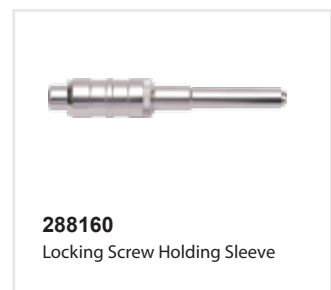
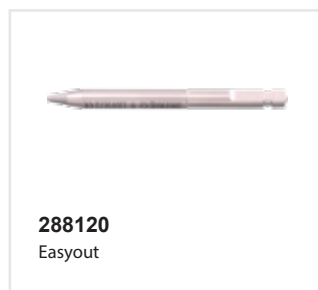
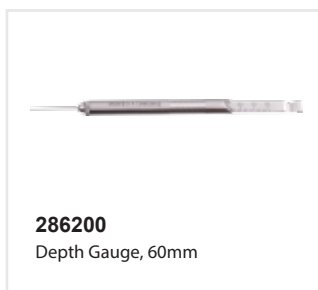
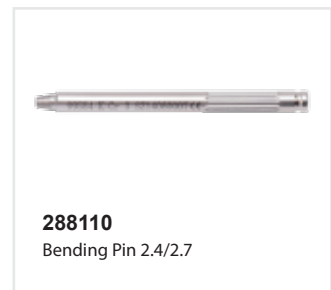
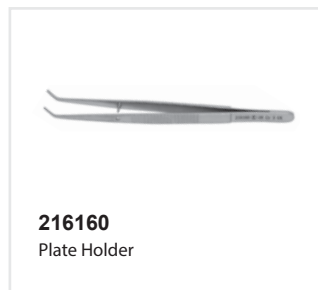
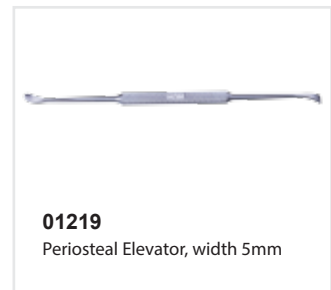
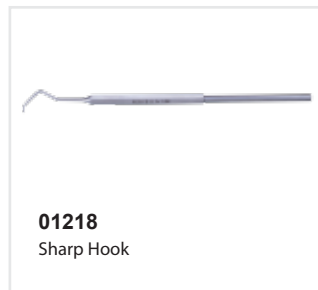
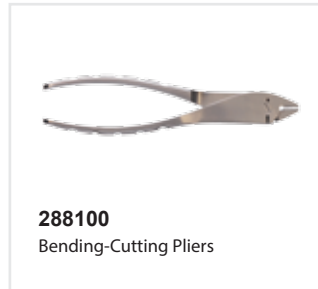

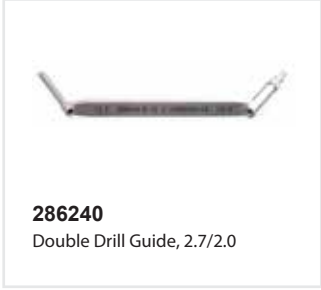
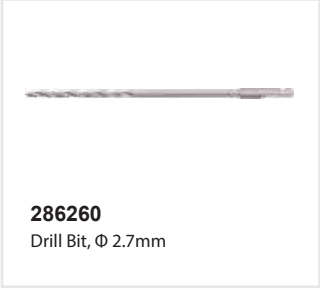
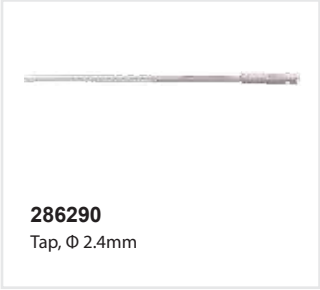
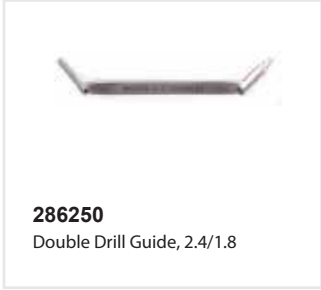
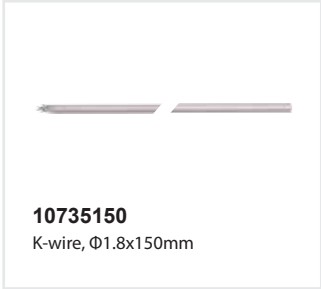
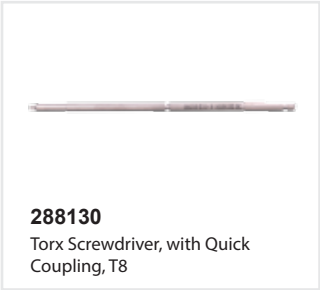

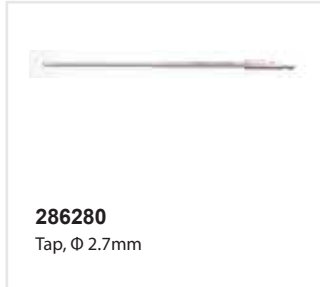

MonoLoc Locking Compression Plates System

- LCP 2.7, LCP 2.7/3.5, LCP 3.5, LCP 5.0
- Targeting LCP
- TopFix
- MIS



MonoLoc LCP 2.7

Distal Lateral Radius Locking Compression Plates 2.7



Product No.	Holes	Material	Model No.
22555005	5H	PT	SDXG33
22555006	6H	PT	SDXG33

Distal Dorsal Radius Locking Compression T-Plates 2.7



Product No.	Holes	Material	Model No.
22557003	3H	PT	SDXG43
22557004	4H	PT	SDXG43
22557005	5H	PT	SDXG43
22557006	6H	PT	SDXG43
22557007	7H	PT	SDXG43
22557008	8H	PT	SDXG43

Distal Dorsal Radius Locking Compression Oblique L-Plates 2.7



Product No.	Holes	Direction	Material	Model No.
22556203	3+3H	Left	PT	SDXG51
22556204	3+4H	Left	PT	SDXG51
22556103	3+3H	Right	PT	SDXG52
22556104	3+4H	Right	PT	SDXG52

Distal Dorsal Radius Locking Compression L-Plates II 2.7



Product No.	Holes	Direction	Material	Model No.
22558203	3H	Left	PT	SDXG35
22558204	4H	Left	PT	SDXG35
22558103	3H	Right	PT	SDXG34
22558104	4H	Right	PT	SDXG34

Distal Radius Volar LCP



Product No.	Holes	Direction	Material	Model No.
29568302	3H	Right	PT	SDXG88
29568300	4H	Right	PT	SDXG88
29568301	7H	Right	PT	SDXG88
29568402	3H	Left	PT	SDXG87
29568400	4H	Left	PT	SDXG87
29568401	7H	Left	PT	SDXG87

Distal Radius Volar Column Plates I 2.7



Product No.	Holes	Direction	Material	Model No.
22559203	9+3H	Left	PT	SDXG59
22559204	9+4H	Left	PT	SDXG59
22559205	9+5H	Left	PT	SDXG59
22559103	9+3H	Right	PT	SDXG59
22559104	9+4H	Right	PT	SDXG59
22559105	9+5H	Right	PT	SDXG59

Distal Radius Volar Column Plates II 2.7



Product No.	Holes	Direction	Material	Model No.
22560203	8+3H	Left	PT	SDXG59
22560204	8+4H	Left	PT	SDXG59
22560205	8+5H	Left	PT	SDXG59
22560206	8+6H	Left	PT	SDXG59
22560208	8+8H	Left	PT	SDXG59
22560210	8+10H	Left	PT	SDXG59
22560212	8+12H	Left	PT	SDXG59
22560103	8+3H	Right	PT	SDXG59
22560104	8+4H	Right	PT	SDXG59
22560105	8+5H	Right	PT	SDXG59
22560106	8+6H	Right	PT	SDXG59
22560108	8+8H	Right	PT	SDXG59
22560110	8+10H	Right	PT	SDXG59
22560112	8+12H	Right	PT	SDXG59

Distal Radius LCP Plate, Volar, 2.7



Product No.	Holes	Direction	Material	Model No.
22572103	5+3H	Right	PT	SDXG54
22572104	5+4H	Right	PT	SDXG54
22572105	5+5H	Right	PT	SDXG54
22572106	5+6H	Right	PT	SDXG54
22572108	5+8H	Right	PT	SDXG54
22572110	5+10H	Right	PT	SDXG54
22572112	5+12H	Right	PT	SDXG54
22572203	5+3H	Left	PT	SDXG53
22572204	5+4H	Left	PT	SDXG53
22572205	5+5H	Left	PT	SDXG53
22572206	5+6H	Left	PT	SDXG53
22572208	5+8H	Left	PT	SDXG53
22572210	5+10H	Left	PT	SDXG53
22572212	5+12H	Left	PT	SDXG53

2.7mm Locking Head Screw, self-tapping



Product No.	Length	Material	Model No.
32580006	6mm	TA	SDLD01
32580008	8mm	TA	SDLD01
32580010	10mm	TA	SDLD01
32580012	12mm	TA	SDLD01
32580014	14mm	TA	SDLD01
32580016	16mm	TA	SDLD01
32580018	18mm	TA	SDLD01
32580020	20mm	TA	SDLD01
32580022	22mm	TA	SDLD01
32580024	24mm	TA	SDLD01
32580026	26mm	TA	SDLD01
32580028	28mm	TA	SDLD01
32580030	30mm	TA	SDLD01
32580032	32mm	TA	SDLD01
32580034	34mm	TA	SDLD01



Product No.	Length	Material	Model No.
32580036	36mm	TA	SDLD01
32580038	38mm	TA	SDLD01
32580040	40mm	TA	SDLD01
32580042	42mm	TA	SDLD01
32580044	44mm	TA	SDLD01
32580046	46mm	TA	SDLD01
32580048	48mm	TA	SDLD01
32580050	50mm	TA	SDLD01

2.7 mm Cortex Screw, self-tapping



Product No.	Length	Material	Model No.
30375010	10mm	TA	HAQ06
30375012	12mm	TA	HAQ06
30375014	14mm	TA	HAQ06
30375016	16mm	TA	HAQ06
30375018	18mm	TA	HAQ06
30375020	20mm	TA	HAQ06
30375022	22mm	TA	HAQ06
30375024	24mm	TA	HAQ06
30375026	26mm	TA	HAQ06
30375028	28mm	TA	HAQ06
30375030	30mm	TA	HAQ06
30375032	32mm	TA	HAQ06
30375034	34mm	TA	HAQ06
30375036	36mm	TA	HAQ06
30375038	38mm	TA	HAQ06
30375040	40mm	TA	HAQ06
30375042	42mm	TA	HAQ06
30375044	44mm	TA	HAQ06
30375046	46mm	TA	HAQ06
30375048	48mm	TA	HAQ06
30375050	50mm	TA	HAQ06

2.4 mm Cortex Screw, self-tapping



Product No.	Length	Material	Model No.
30374006	6mm	TA	HAQ06
30374008	8mm	TA	HAQ06
30374010	10mm	TA	HAQ06
30374012	12mm	TA	HAQ06
30374014	14mm	TA	HAQ06
30374016	16mm	TA	HAQ06
30374018	18mm	TA	HAQ06
30374020	20mm	TA	HAQ06
30374022	22mm	TA	HAQ06
30374024	24mm	TA	HAQ06
30374026	26mm	TA	HAQ06
30374028	28mm	TA	HAQ06
30374030	30mm	TA	HAQ06
30374032	32mm	TA	HAQ06
30374034	34mm	TA	HAQ06
30374036	36mm	TA	HAQ06
30374038	38mm	TA	HAQ06
30374040	40mm	TA	HAQ06
30374042	42mm	TA	HAQ06

2.0mm Smooth Screw



Product No.	Size	Material	Model No.
39568210	2.0x10mm	TA	SDL04
39568212	2.0x12mm	TA	SDL04
39568214	2.0x14mm	TA	SDL04
39568216	2.0x16mm	TA	SDL04
39568218	2.0x18mm	TA	SDL04
39568220	2.0x20mm	TA	SDL04
39568222	2.0x22mm	TA	SDL04
39568224	2.0x24mm	TA	SDL04
39568226	2.0x26mm	TA	SDL04
39568228	2.0x28mm	TA	SDL04
39568230	2.0x30mm	TA	SDL04

MonoLoc LCP 2.7/3.5

Anterolateral Clavicular LCP Plate, 2.7/3.5



Product No.	Size	Direction	Material	Model No.
22578110	10H	Right	PT	SDXZ07
22578111	11H	Right	PT	SDXZ07
22578112	12H	Right	PT	SDXZ07
22578113	13H	Right	PT	SDXZ07
22578114	14H	Right	PT	SDXZ07
22578115	15H	Right	PT	SDXZ07
22578210	10H	Left	PT	SDXZ08
22578211	11H	Left	PT	SDXZ08
22578212	12H	Left	PT	SDXZ08
22578213	13H	Left	PT	SDXZ08
22578214	14H	Left	PT	SDXZ08
22578215	15H	Left	PT	SDXZ08

Distal Dorsal Humeral Locking Compression Plates, 2.7/3.5



Product No.	Size	Direction	Material	Model No.
22594203	6+3H	Left	PT	SDXG30
22594205	6+5H	Left	PT	SDXG30
22594207	6+7H	Left	PT	SDXG30
22594209	6+9H	Left	PT	SDXG30
22594103	6+3H	Right	PT	SDXG29
22594105	6+5H	Right	PT	SDXG29
22594107	6+7H	Right	PT	SDXG29
22594109	6+9H	Right	PT	SDXG29

Distal Medial Humeral Locking Compression Plates 2.7/3.5



Product No.	Size	Direction	Material	Model No.
22579106	3+3 H	Right	PT	SDXG10
22579108	3+5 H	Right	PT	SDXG10
22579110	3+7 H	Right	PT	SDXG10
22579112	3+9 H	Right	PT	SDXG10
22579206	3+3 H	Left	PT	SDXG09
22579208	3+5 H	Left	PT	SDXG09
22579210	3+7 H	Left	PT	SDXG09
22579212	3+9 H	Left	PT	SDXG09

Locking Lateral Distal Fibula Plates, 2.7/3.5



Product No.	Size	Direction	Material	Model No.
22550103	5+3H	Right	PT	SDDG19
22550104	5+4H	Right	PT	SDDG19
22550105	5+5H	Right	PT	SDDG19
22550106	5+6H	Right	PT	SDDG19
22550107	5+7H	Right	PT	SDDG19
22550109	5+9H	Right	PT	SDDG19
22550111	5+11H	Right	PT	SDDG19
22550113	5+13H	Right	PT	SDDG19
22550115	5+15H	Right	PT	SDDG19



Product No.	Size	Direction	Material	Model No.
22550203	5+3H	Left	PT	SDDG20
22550204	5+4H	Left	PT	SDDG20
22550205	5+5H	Left	PT	SDDG20
22550206	5+6H	Left	PT	SDDG20
22550207	5+7H	Left	PT	SDDG20
22550209	5+9H	Left	PT	SDDG20
22550211	5+11H	Left	PT	SDDG20
22550213	5+13H	Left	PT	SDDG20
22550215	5+15H	Left	PT	SDDG20



MonoLoc LCP 3.5

Locking Compression Plates 3.5



Product No.	Size	Material	Model No.
22501004	4H	PT	SDXG37
22501005	5H	PT	SDXG37
22501006	6H	PT	SDXG37
22501007	7H	PT	SDXG37
22501008	8H	PT	SDXG37
22501009	9H	PT	SDXG37
22501010	10H	PT	SDXG37
22501011	11H	PT	SDXG37
22501012	12H	PT	SDXG37

Metaphyseal Locking Compression Plates 3.5



Product No.	Size	Material	Model No.
29593101	4H	PT	SDDZ40
29593102	5H	PT	SDDG40
22506006	6H	PT	SDDG40
22506007	7H	PT	SDDG40
22506008	8H	PT	SDDG40
22506009	9H	PT	SDDG40
22506010	10H	PT	SDDG40
22506011	11H	PT	SDDG40
22506012	12H	PT	SDDG40
22506014	14H	PT	SDDG40
22506016	16H	PT	SDDG40
22506018	18H	PT	SDDG40



Metaphyseal Locking Compression Plates 3.5/4.5



Product No.	Size	Material	Model No.
22520003	5+3H	PT	SDDG41
22520004	5+4H	PT	SDDG41
22520005	5+5H	PT	SDDG41
22520006	5+6H	PT	SDDG41
22520007	5+7H	PT	SDDG41
22520008	5+8H	PT	SDDG41
22520009	5+9H	PT	SDDG41
22520011	5+11H	PT	SDDG41
22520013	5+13H	PT	SDDG41
22520015	5+15H	PT	SDDG41

Proximal Humeral Locking Compression Plates 3.5, long



Product No.	Size	Material	Model No.
22509005	5H	PT	SDXG36
22509006	6H	PT	SDXG36
22509008	8H	PT	SDXG36
22509010	10H	PT	SDXG36
22509012	12H	PT	SDXG36

Proximal Humeral Locking Compression Plates 3.5, short



Product No.	Size	Material	Model No.
22508003	3H	PT	SDXG36
22508005	5H	PT	SDXG36

Distal Medial Humeral Locking Compression Plates 3.5



Product No.	Size	Material	Model No.
22513003	4+3H	PT	SDXG32
22513005	4+5H	PT	SDXG32
22513007	4+7H	PT	SDXG32
22513009	4+9H	PT	SDXG32
22513011	4+11H	PT	SDXG32

Olecranal Locking Compression Plates 3.5



Product No.	Direction	Size	Material	Model No.
22573104	Right	4H	PT	SDXG42
22573106	Right	6H	PT	SDXG42
22573108	Right	8H	PT	SDXG42
22573110	Right	10H	PT	SDXG42
22573112	Right	12H	PT	SDXG42
22573204	Left	4H	PT	SDXG41
22573206	Left	6H	PT	SDXG41
22573208	Left	8H	PT	SDXG41
22573210	Left	10H	PT	SDXG41
22573212	Left	12H	PT	SDXG41

Clavicular Locking Compression Plates 3.5



Product No.	Direction	Holes	Material	Model No.
22510202	Left	3+2H	PT	SDXG25
22510203	Left	3+3H	PT	SDXG25
22510205	Left	3+5H	PT	SDXG25
22510207	Left	3+7H	PT	SDXG25
22510102	Right	3+2H	PT	SDXG26
22510103	Right	3+3H	PT	SDXG26
22510105	Right	3+5H	PT	SDXG26
22510107	Right	3+7H	PT	SDXG26

Clavicular Locking S-Plates 3.5



Product No.	Direction	Holes	Material	Model No.
22554206	Left	6H	PT	SDXZ28
22554207	Left	7H	PT	SDXZ28
22554208	Left	8H	PT	SDXZ28
22554209	Left	9H	PT	SDXZ28
22554210	Left	10H	PT	SDXZ28
22554212	Left	12H	PT	SDXZ28
22554106	Right	6H	PT	SDXZ27
22554107	Right	7H	PT	SDXZ27
22554108	Right	8H	PT	SDXZ27
22554109	Right	9H	PT	SDXZ27
22554110	Right	10H	PT	SDXZ27
22554112	Right	12H	PT	SDXZ27

Clavicular Reconstruction LCP Plate 3.5



Product No.	Size	Direction	Material	Model No.
22563106	6H	Right	PT	SDXG22
22563107	7H	Right	PT	SDXG22
22563108	8H	Right	PT	SDXG22
22563206	6H	Left	PT	SDXG23
22563207	7H	Left	PT	SDXG23
22563208	8H	Left	PT	SDXG23

Reconstruction Locking Plates 3.5



Product No.	Holes	Material	Model No.
22551005	5H	PT	SDDZ36
22551006	6H	PT	SDDZ36
22551007	7H	PT	SDDZ36
22551008	8H	PT	SDDZ36
22551009	9H	PT	SDDZ36
22551010	10H	PT	SDDZ36
22551011	11H	PT	SDDZ36
22551012	12H	PT	SDDZ36
22551013	13H	PT	SDDZ36
22551014	14H	PT	SDDZ36
22551015	15H	PT	SDDZ36
22551016	16H	PT	SDDZ36
22551018	18H	PT	SDDZ36

Calcaneal Locking Plates 3.5



Product No.	Direction	Material	Model No.
22553215	Left	PT	SDXZ71
22553115	Right	PT	SDXZ71

Distal Tibia Locking Compression Plates 3.5



Product No.	Direction	Holes	Material	Model No.
22528204	Left	4H	PT	SDDG44
22528206	Left	6H	PT	SDDG44
22528208	Left	8H	PT	SDDG44
22528210	Left	10H	PT	SDDG44
22528212	Left	12H	PT	SDDG44

Product No.	Direction	Holes	Material	Model No.
22528214	Left	14H	PT	SDDG44
22528104	Right	4H	PT	SDDG45
22528106	Right	6H	PT	SDDG45
22528108	Right	8H	PT	SDDG45
22528110	Right	10H	PT	SDDG45
22528112	Right	12H	PT	SDDG45
22528114	Right	14H	PT	SDDG45

Distal Tibia Locking Compression Plates 3.5 II



Product No.	Direction	Holes	Material	Model No.
22561104	Right	8+4H	PT	SDDG59
22561106	Right	8+6H	PT	SDDG59
22561108	Right	8+8H	PT	SDDG59
22561110	Right	8+10H	PT	SDDG59
22561204	Left	8+4H	PT	SDDG59
22561206	Left	8+6H	PT	SDDG59
22561208	Left	8+8H	PT	SDDG59
22561210	Left	8+10H	PT	SDDG59

LCP Anterolateral Distal Tibia L Plate 3.5



Product No.	Direction	Holes	Material	Model No.
22574109	Right	9H	PT	SDDG50
22574111	Right	11H	PT	SDDG50
22574113	Right	13H	PT	SDDG50
22574115	Right	15H	PT	SDDG50
22574117	Right	17H	PT	SDDG50
22574119	Right	19H	PT	SDDG50
22574209	Left	9H	PT	SDDG51
22574211	Left	11H	PT	SDDG51
22574213	Left	13H	PT	SDDG51
22574215	Left	15H	PT	SDDG51
22574217	Left	17H	PT	SDDG51
22574219	Left	19H	PT	SDDG51

Pelvic Locking Reconstruction Plate 3.5



Product No.	Holes	Material	Model No.
22595008	8H	PT	SDDZ37
22595010	10H	PT	SDDZ37
22595012	12H	PT	SDDZ37
22595014	14H	PT	SDDZ37
22595016	16H	PT	SDDZ37

3.5mm Locking Head Screws, self-tapping



Product No.	Size	Material	Model No.
31451010	3.5×10mm	TA	SDLD01
31451012	3.5×12mm	TA	SDLD01
31451014	3.5×14mm	TA	SDLD01
31451016	3.5×16mm	TA	SDLD01
31451018	3.5×18mm	TA	SDLD01
31451020	3.5×20mm	TA	SDLD01
31451022	3.5×22mm	TA	SDLD01
31451024	3.5×24mm	TA	SDLD01
31451026	3.5×26mm	TA	SDLD01
31451028	3.5×28mm	TA	SDLD01
31451030	3.5×30mm	TA	SDLD01
31451032	3.5×32mm	TA	SDLD01
31451034	3.5×34mm	TA	SDLD01
31451036	3.5×36mm	TA	SDLD01
31451038	3.5×38mm	TA	SDLD01
31451040	3.5×40mm	TA	SDLD01
31451045	3.5×45mm	TA	SDLD01
31451050	3.5×50mm	TA	SDLD01
31451055	3.5×55mm	TA	SDLD01
31451060	3.5×60mm	TA	SDLD01
31451065	3.5×65mm	TA	SDLD01
31451070	3.5×70mm	TA	SDLD01
31451075	3.5×75mm	TA	SDLD01
31451080	3.5×80mm	TA	SDLD01

3.5mm Locking Head Screws, self-tapping, self-drilling



Product No.	Size	Material	Model No.
39782012	3.5×12mm	TA	SDLD02
39782014	3.5×14mm	TA	SDLD02
39782016	3.5×16mm	TA	SDLD02
39782018	3.5×18mm	TA	SDLD02
39782020	3.5×20mm	TA	SDLD02
39782022	3.5×22mm	TA	SDLD02
39782024	3.5×24mm	TA	SDLD02
39782026	3.5×26mm	TA	SDLD02
39782028	3.5×28mm	TA	SDLD02
39782030	3.5×30mm	TA	SDLD02
39782032	3.5×32mm	TA	SDLD02
39782034	3.5×34mm	TA	SDLD02
39782036	3.5×36mm	TA	SDLD02
39782038	3.5×38mm	TA	SDLD02
39782040	3.5×40mm	TA	SDLD02
39782045	3.5×45mm	TA	SDLD02
39782050	3.5×50mm	TA	SDLD02
39782055	3.5×55mm	TA	SDLD02
39782060	3.5×60mm	TA	SDLD02
39782065	3.5×65mm	TA	SDLD02
39782070	3.5×70mm	TA	SDLD02

Spacer, 2mm Length



Product No.	Length	Material	Model No.
31453005	3.5mm	TA	SDLD04

MonoLoc LCP 5.0

Locking Compression Plates 4.5/5.0, narrow



Product No.	Size	Material	Model No.
22521004	4H	PT	SDDZ38
22521005	5H	PT	SDDG38
22521006	6H	PT	SDDG38
22521007	7H	PT	SDDG38
22521008	8H	PT	SDDG38
22521009	9H	PT	SDDG38
22521010	10H	PT	SDDG38
22521011	11H	PT	SDDG38
22521012	12H	PT	SDDG38
22521013	13H	PT	SDDG38
22521014	14H	PT	SDDG38
22521016	16H	PT	SDDG38

Locking Compression Plates 4.5/5.0, broad



Product No.	Size	Material	Model No.
22587006	6H	PT	SDDG39
22587007	7H	PT	SDDG39
22587008	8H	PT	SDDG39
22587009	9H	PT	SDDG39
22587010	10H	PT	SDDG39
22587011	11H	PT	SDDG39
22587012	12H	PT	SDDG39
22587013	13H	PT	SDDG39
22587014	14H	PT	SDDG39
22587015	15H	PT	SDDG39
22587016	16H	PT	SDDG39
22587017	17H	PT	SDDG39
22587018	18H	PT	SDDG39

Proximal Lateral Femoral Locking Compression Plates 4.5/5.0



Product No.	Direction	Holes	Material	Model No.
22531205	Left	5+5H	PT	SDDG47
22531207	Left	5+7H	PT	SDDG47
22531209	Left	5+9H	PT	SDDG47
22531211	Left	5+11H	PT	SDDG47
22531213	Left	5+13H	PT	SDDG47
22531105	Right	5+5H	PT	SDDG46
22531107	Right	5+7H	PT	SDDG46
22531109	Right	5+9H	PT	SDDG46
22531111	Right	5+11H	PT	SDDG46
22531113	Right	5+13H	PT	SDDG46

Proximal Lateral Femoral LCP Plate



Product No.	Direction	Holes	Material	Model No.
22575204	Left	5+4H	PT	SDDG47
22575206	Left	5+6H	PT	SDDG47
22575208	Left	5+8H	PT	SDDG47
22575210	Left	5+10H	PT	SDDG47
22575212	Left	5+12H	PT	SDDG47
22575104	Right	5+4H	PT	SDDG46
22575106	Right	5+6H	PT	SDDG46
22575108	Right	5+8H	PT	SDDG46
22575110	Right	5+10H	PT	SDDG46
22575112	Right	5+12H	PT	SDDG46



Distal Femoral Locking Compression Plates 4.5/5.0



Product No.	Direction	Holes	Material	Model No.
22527205	Left	5H	PT	SDDG52
22527207	Left	7H	PT	SDDG52
22527209	Left	9H	PT	SDDG52
22527211	Left	11H	PT	SDDG52
22527213	Left	13H	PT	SDDG52
22527105	Right	5H	PT	SDDG53
22527107	Right	7H	PT	SDDG53
22527109	Right	9H	PT	SDDG53
22527111	Right	11H	PT	SDDG53
22527113	Right	13H	PT	SDDG53

Proximal Lateral Tibia Locking Compression Plates 4.5/5.0



Product No.	Holes	Holes	Material	Model No.
22526205	5H	Left	PT	SDDG49
22526207	7H	Left	PT	SDDG49
22526209	9H	Left	PT	SDDG49
22526211	11H	Left	PT	SDDG49
22526213	13H	Left	PT	SDDG49
22526105	5H	Right	PT	SDDG48
22526107	7H	Right	PT	SDDG48
22526109	9H	Right	PT	SDDG48
22526111	11H	Right	PT	SDDG48
22526113	13H	Right	PT	SDDG48

Locking Medial Proximal Tibial plate



Product No.	Direction	Holes	Material	Model No.
22589104	Right	3+4H	PT	SDDZ22
22589105	Right	3+5H	PT	SDDG22
22589106	Right	3+6H	PT	SDDG22
22589107	Right	3+7H	PT	SDDG22
22589108	Right	3+8H	PT	SDDG22
22589109	Right	3+9H	PT	SDDG22
22589110	Right	3+10H	PT	SDDG22
22589111	Right	3+11H	PT	SDDG22
22589112	Right	3+12H	PT	SDDG22
22589113	Right	3+13H	PT	SDDG22
22589204	Left	3+4H	PT	SDDZ21
22589205	Left	3+5H	PT	SDDG21
22589206	Left	3+6H	PT	SDDG21
22589207	Left	3+7H	PT	SDDG21
22589208	Left	3+8H	PT	SDDG21
22589209	Left	3+9H	PT	SDDG21
22589210	Left	3+10H	PT	SDDG21
22589211	Left	3+11H	PT	SDDG21
22589212	Left	3+12H	PT	SDDG21
22589213	Left	3+13H	PT	SDDG21

Locking Proximal Tibial Plate



Product No.	Direction	Holes	Material	Model No.
22591104	Right	3+4H	PT	SDDG13
22591105	Right	3+5H	PT	SDDG13
22591106	Right	3+6H	PT	SDDG13
22591107	Right	3+7H	PT	SDDG13



Product No.	Direction	Holes	Material	Model No.
22591108	Right	3+8H	PT	SDDG13
22591109	Right	3+9H	PT	SDDG13
22591110	Right	3+10H	PT	SDDG13
22591204	Left	3+4H	PT	SDDG14
22591205	Left	3+5H	PT	SDDG14
22591206	Left	3+6H	PT	SDDG14
22591207	Left	3+7H	PT	SDDG14
22591208	Left	3+8H	PT	SDDG14
22591209	Left	3+9H	PT	SDDG14
22591210	Left	3+10H	PT	SDDG14

Reconstruction Locking Plates 5.0



Product No.	Holes	Material	Model No.
22552003	3H	PT	SDDZ36
22552004	4H	PT	SDDZ36
22552005	5H	PT	SDDZ36
22552006	6H	PT	SDDZ36
22552007	7H	PT	SDDZ36
22552008	8H	PT	SDDZ36
22552009	9H	PT	SDDZ36
22552010	10H	PT	SDDZ36
22552011	11H	PT	SDDZ36
22552012	12H	PT	SDDZ36
22552013	13H	PT	SDDZ36
22552014	14H	PT	SDDZ36
22552015	15H	PT	SDDZ36
22552016	16H	PT	SDDZ36



TopFix Osteotomy

Medial High Tibia Plate



Product No.	Size	Material	Model No.
29401800	4H	PT	SDDG65

Lateral High Tibia Plate



Product No.	Direction	Size	Material	Model No.
29402000	Right	3H	PT	SDDG66
29401900	Left	3H	PT	SDDG67

Lateral Distal Femur Plate



Product No.	Direction	Size	Material	Model No.
29402200	Right	4H	PT	SDDG68
29402100	Left	4H	PT	SDDG69

MIS Distal Femoral Plates



Product No.	Direction	Size	Material	Model No.
22541205	Left	5H	PT	SDDZ52
22541207	Left	7H	PT	SDDZ52
22541209	Left	9H	PT	SDDZ52
22541211	Left	11H	PT	SDDZ52
22541213	Left	13H	PT	SDDZ52
22541105	Right	5H	PT	SDDZ53
22541107	Right	7H	PT	SDDZ53
22541109	Right	9H	PT	SDDZ53
22541111	Right	11H	PT	SDDZ53
22541113	Right	13H	PT	SDDZ53

MIS Proximal Lateral Tibia Plates



Product No.	Direction	Size	Material	Model No.
22542205	Left	5H	PT	SDDZ49
22542207	Left	7H	PT	SDDZ49
22542209	Left	9H	PT	SDDZ49
22542211	Left	11H	PT	SDDZ49
22542213	Left	13H	PT	SDDZ49
22542105	Right	5H	PT	SDDZ48
22542107	Right	7H	PT	SDDZ48
22542109	Right	9H	PT	SDDZ48
22542111	Right	11H	PT	SDDZ48
22542113	Right	13H	PT	SDDZ48

5.0mm Locking Head Screws, self-tapping



Product No.	Size	Material	Model No.
31452014	5.0×14mm	TA	SDLD01
31452016	5.0×16mm	TA	SDLD01
31452018	5.0×18mm	TA	SDLD01
31452020	5.0×20mm	TA	SDLD01
31452022	5.0×22mm	TA	SDLD01
31452024	5.0×24mm	TA	SDLD01
31452026	5.0×26mm	TA	SDLD01
31452028	5.0×28mm	TA	SDLD01
31452030	5.0×30mm	TA	SDLD01
31452032	5.0×32mm	TA	SDLD01
31452034	5.0×34mm	TA	SDLD01
31452036	5.0×36mm	TA	SDLD01
31452038	5.0×38mm	TA	SDLD01
31452040	5.0×40mm	TA	SDLD01
31452042	5.0×42mm	TA	SDLD01
31452044	5.0×44mm	TA	SDLD01
31452046	5.0×46mm	TA	SDLD01
31452048	5.0×48mm	TA	SDLD01
31452050	5.0×50mm	TA	SDLD01
31452055	5.0×55mm	TA	SDLD01
31452060	5.0×60mm	TA	SDLD01
31452065	5.0×65mm	TA	SDLD01
31452070	5.0×70mm	TA	SDLD01
31452075	5.0×75mm	TA	SDLD01
31452080	5.0×80mm	TA	SDLD01
31452085	5.0×85mm	TA	SDLD01
31452090	5.0×90mm	TA	SDLD01



5.0mm Locking Head Screws, self-tapping, self-drilling



Product No.	Size	Material	Model No.
32582014	5.0×14mm	TA	SDLD02
32582016	5.0×16mm	TA	SDLD02
32582018	5.0×18mm	TA	SDLD02
32582020	5.0×20mm	TA	SDLD02
32582022	5.0×22mm	TA	SDLD02
32582024	5.0×24mm	TA	SDLD02
32582026	5.0×26mm	TA	SDLD02
32582028	5.0×28mm	TA	SDLD02
32582030	5.0×30mm	TA	SDLD02
32582032	5.0×32mm	TA	SDLD02
32582034	5.0×34mm	TA	SDLD02
32582036	5.0×36mm	TA	SDLD02
32582038	5.0×38mm	TA	SDLD02
32582040	5.0×40mm	TA	SDLD02
32582042	5.0×42mm	TA	SDLD02
32582044	5.0×44mm	TA	SDLD02
32582046	5.0×46mm	TA	SDLD02
32582048	5.0×48mm	TA	SDLD02
32582050	5.0×50mm	TA	SDLD02
32582055	5.0×55mm	TA	SDLD02
32582060	5.0×60mm	TA	SDLD02
32582065	5.0×65mm	TA	SDLD02
32582070	5.0×70mm	TA	SDLD02
32582075	5.0×75mm	TA	SDLD02
32582080	5.0×80mm	TA	SDLD02
32582085	5.0×85mm	TA	SDLD02



Spacer, 2mm Length



Product No.	Size	Material	Model No.
31454007	5.0mm	TA	SDLD04

Targeting Proximal Humeral Locking Compression Plates 3.5, short



Product No.	Holes	Material	Model No.
22547003	3H	PT	SDXG36
22547005	5H	PT	SDXG36



**Targeting Proximal Humeral Locking Compression
Plates 3.5, long**



Product No.	Holes	Material	Model No.
22545005	5H	PT	SDXG36
22545006	6H	PT	SDXG36
22545008	8H	PT	SDXG36
22545010	10H	PT	SDXG36

**Targeting Distal Femoral Locking Compression
Plates 4.5/5.0**



Product No.	Direction	Size	Material	Model No.
22543205	Left	5H	PT	SDDG52
22543207	Left	7H	PT	SDDG52
22543209	Left	9H	PT	SDDG52
22543211	Left	11H	PT	SDDG52
22543213	Left	13H	PT	SDDG52
22543105	Right	5H	PT	SDDG53
22543107	Right	7H	PT	SDDG53
22543109	Right	9H	PT	SDDG53
22543111	Right	11H	PT	SDDG53
22543113	Right	13H	PT	SDDG53



**Targeting Proximal Tibia Locking Compression
Plates 4.5/5.0**



Product No.	Direction	Size	Material	Model No.
22544205	Left	5H	PT	SDDG49
22544207	Left	7H	PT	SDDG49
22544209	Left	9H	PT	SDDG49
22544211	Left	11H	PT	SDDG49
22544213	Left	13H	PT	SDDG49
22544105	Right	5H	PT	SDDG48
22544107	Right	7H	PT	SDDG48
22544109	Right	9H	PT	SDDG48
22544111	Right	11H	PT	SDDG48
22544113	Right	13H	PT	SDDG48

Monoloc LCP 2.7mm Instruments Set

Code	Product Description	Qty
287900	MonoLoc LCP 2.7mm System Instruments Set	
898200	2.7mm LCP Implants Tray	1
898137	2.7mm LCP Screw Case-PPSU	1
898346	MonoLoc LCP 2.7mm System Instruments Set(Empty)-PPSU	1
286120	Drill Guide 2.0	2
286130	Drill Bit, Φ 2.0mm	2
286220	Drill Guide 1.8	2
286230	Drill Bit, Φ 1.8mm	2
286140	Torque-limiting Screwdriver, T8	1
286150	Screw Holding Sleeve	1
286200	Depth Gauge, 60mm	1
286210	StarDrive Screwdriver Shaft, T8	1
030100	T-Handle with Quick Coupling	1
286190	Easyout	1
286260	Drill Bit, Φ 2.7mm	2
286270	Drill Bit, Φ 2.4mm	2
286280	Tap, Φ 2.7mm	1
286290	Tap, Φ 2.4mm	1
286300	Countersink	1
286310	Screwdriver,self-retaining	1
01214	Bending Irons	2
01123	Reduction Forceps with Points	1
01124	Reduction Forceps with Points, toothed	1
01232	Periosteal Elevator, width 3mm	1
01215	Retractor, width 6mm	1
286240	Double Drill Guide, 2.7/2.0	1
286250	Double Drill Guide, 2.4/1.8	1
10735150	K-wire, Φ 1.8 \times 150mm	3

Please contact your sales representative for final product list.



MonoLoc LCP 2.7mm System Instruments Set



287900

898200

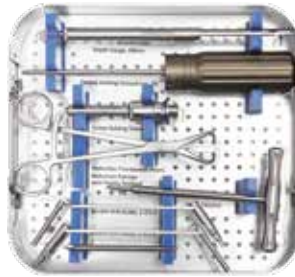

898137

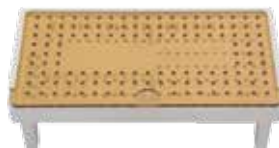

Instruments

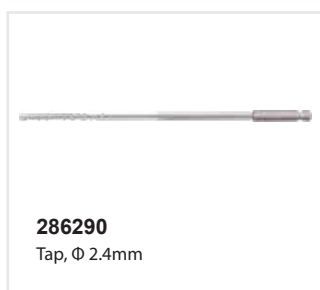
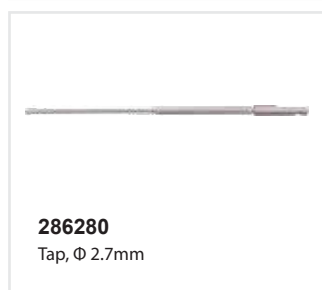
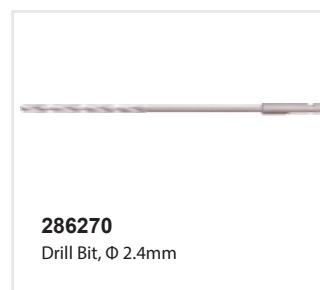
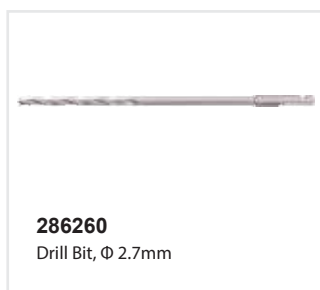
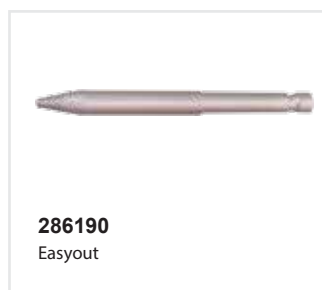
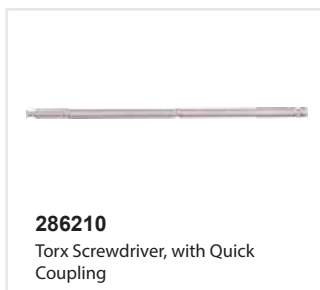
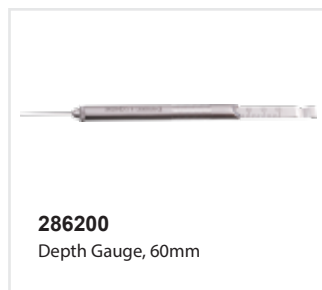
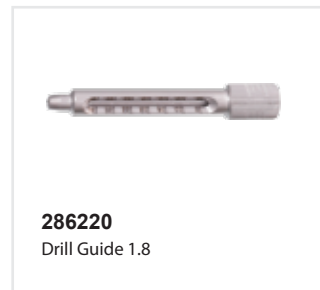

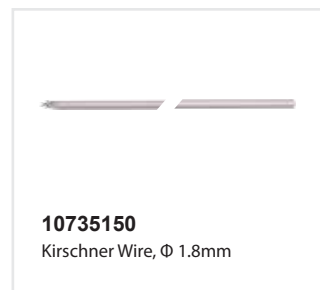
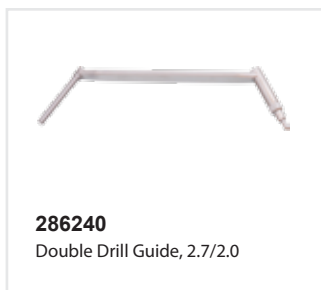
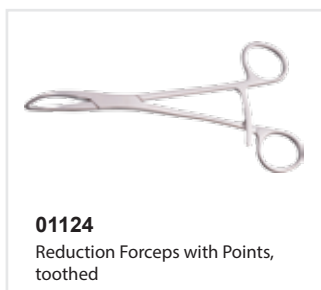
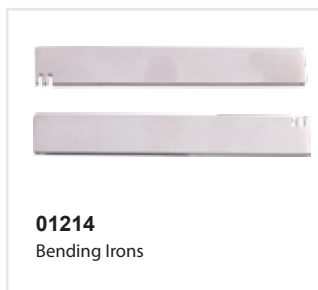

Monoloc LCP 3.5mm Instruments Set

Code	Product Description	Qty
222900	MonoLoc LCP 3.5mm System Instruments Set	
898142	3.5mm LCP Screw Case -PPSU	1
898347	MonoLoc LCP 3.5mm System Instruments Set(Empty)-PPSU	1
221100	Drill Guide 2.6	3
221111	Drill Bit with Stop, Φ 2.6mm	1
222110	Drill Bit with straight shank, Φ 2.6mm	2
221120	Guide Sleeve for K-Wire, Φ 1.2mm	1
221151	Torque-limiting Screwdriver, T15	1
221140	Screw Holding Sleeve for StarDrive Screw	1
221160	Screwdriver, self-retaining	1
221180	Allen Key	1
10736220	Kirschner Wire, Φ 1.2mm	3
221170	Extraction Screw, Φ 3.5mm	1
221190	Drill Bit for Screw Head Removal	1
201150	Trephine	1
010030	Drill Bit, Φ 3.5mm	1
010010	Drill Bit, Φ 2.5mm	1
221200	Torx Screwdriver, with Quick Coupling	1
201120	Double Drill Guide 3.5/2.5	1
201130	Double Drill Sleeve 2.5	1
201200	Depth Gauge, 60mm	1
020020	Tap, Φ 4.0mm	1
020010	Tap, Φ 3.5mm	1
030100	T-handle with Quick Coupling	1
201250	Screw Holding Sleeve for Hex Screw	1
201140	Hex Screwdriver	1
201170	Bone Holding Forceps, self-centering	2
201180	Reduction Forceps, serrated jaws, small	1
201190	Reduction Forceps with Points, small	1
201160	Bending Irons	2

Please contact your sales representative for final product list.



MonoLoc LCP 3.5mm System Instruments Set



222900



898142

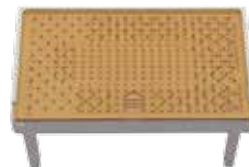



Instruments

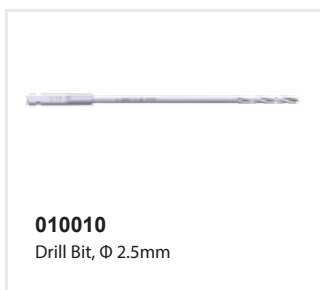
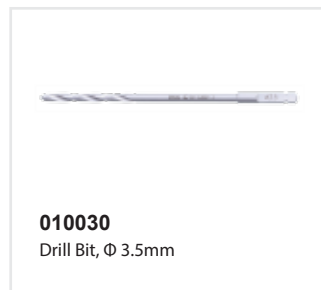
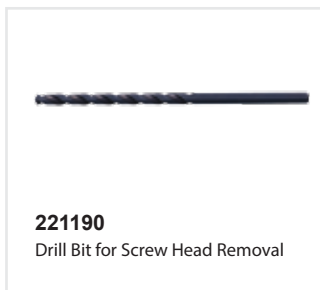
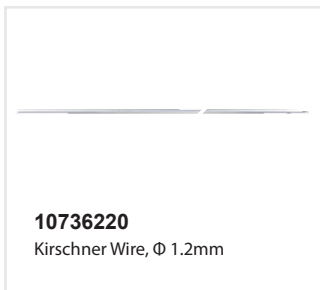
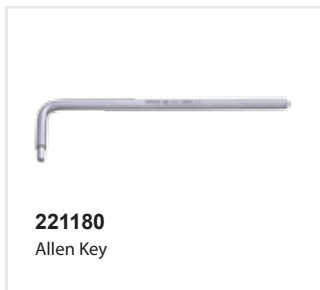
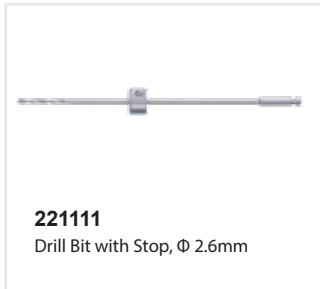
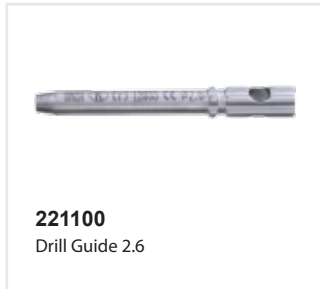

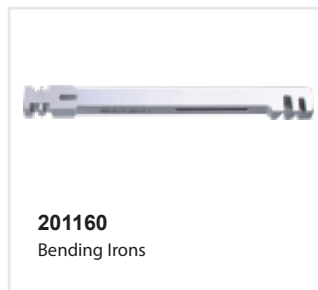
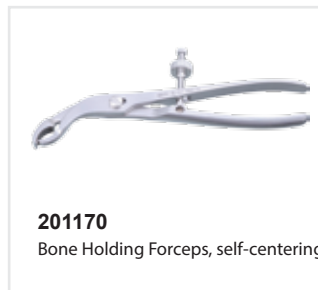

Monoloc LCP 5.0mm Instruments Set

Code	Product Description	Qty
227900	MonoLoc LCP 5.0mm System Instruments Set	
898146	5.0mm LCP Screw Case -PPSU	1
898348	MonoLoc LCP 5.0mm System Instruments Set(Empty)-PPSU	1
226100	Drill Guide 4.1	3
226110	Drill Bit with Stop, Φ 4.1mm	1
227110	Drill Bit with straight shank, Φ 4.1mm	2
226120	Guide Sleeve for K-Wire, Φ 2.0mm	1
226151	Torque-limiting Screwdriver, T25	1
226140	Screw Holding Sleeve for StarDrive Screw	1
226160	Screwdriver, self-retaining	1
226200	Torx Screwdriver, with Quick Coupling	1
226170	Extraction Screw, Φ 5.0mm	1
221180	Allen Key	1
226190	Drill Bit for Screw Head Removal	1
10737230	Kirschner Wire, Φ 2.0mm	3
206110	Double Drill Guide 6.5/3.2	1
206120	Double Drill Guide 4.5/3.2	1
206240	Trephine	1
010040	Drill Bit, Φ 4.5mm	1
010020	Drill Bit, Φ 3.2mm	1
206170	Depth Gauge, 90mm	1
030100	T-handle with Quick Coupling	1
020040	Tap, Φ 6.5mm	1
020030	Tap, Φ 4.5mm	1
206280	Hex Screwdriver	1
206300	Screw Holding Sleeve for Hex Screw	1
206150	Reduction Forceps, serrated jaws, large	1
206160	Reduction Forceps with Points, large	1
206290	Bone Holding Forceps, self-centering	2
206320	Bending Irons, left	1
206340	Bending Irons, right	1

Optional instrument

Code	Product Description	Qty
206330	Plates Bender	1

Please contact your sales representative for final product list.



MonoLoc LCP 5.0mm System Instruments Set



227900

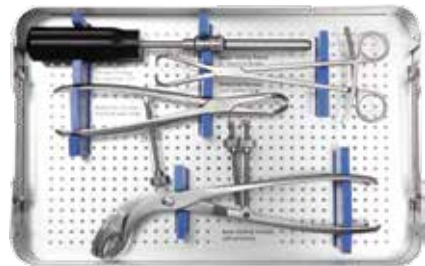
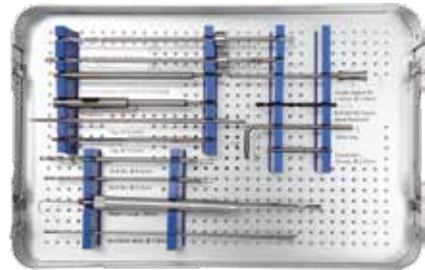
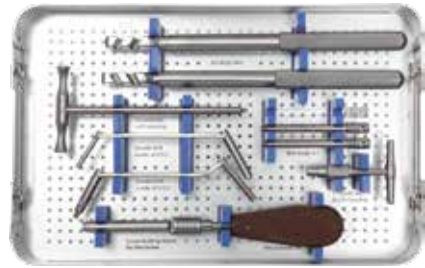

898146



Instruments

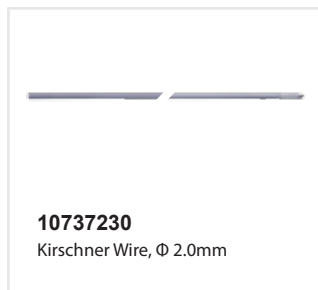
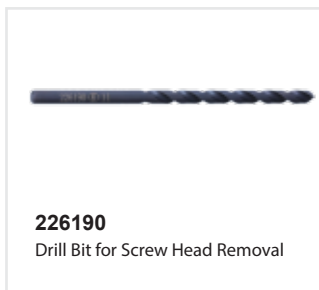
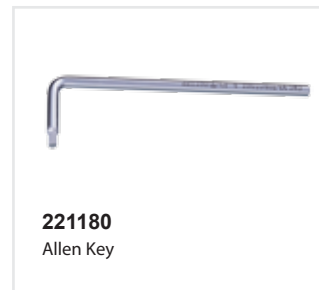

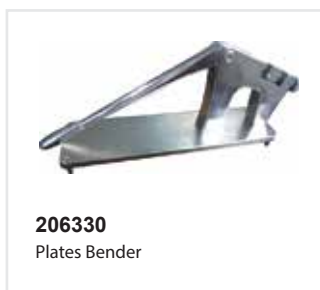
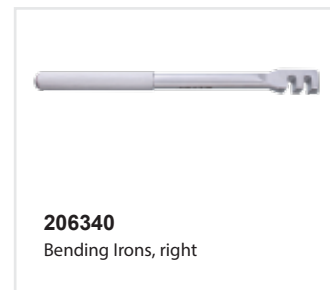
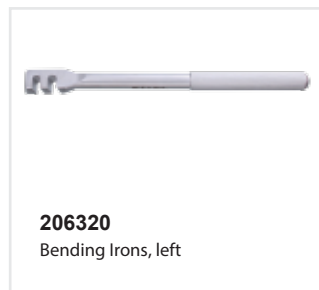
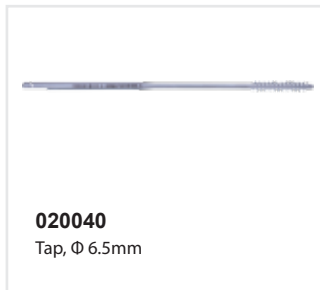



TopFix Osteotomy Instruments set

Code	Product Description	Qty
898165	TopFix Osteotomy Instruments set	1
898356	TopFix Osteotomy Instruments set (Empty)-PPSU	1
898193	TopFix Implants case	1
829100	TopFix Guiding Block for Medial High Tibia	1
226230	TopFix Guiding Block for Lateral High Tibia,left	1
226240	TopFix Guiding Block for Lateral High Tibia,right	1
829130	TopFix Guiding Block for Lateral Distal Femur,left	1
829140	TopFix Guiding Block for Lateral Distal Femur,right	1
829150	TopFix Osteotomy Gap Measuring Device	1
829160	Bone Spreader with 8mm blade,medium handle, soft ratchet	1
829170	TopFix Osteotomy Chisel, width 10mm	1
829180	TopFix Osteotomy Chisel, width 15mm	1
829190	TopFix Osteotomy Chisel, width 20mm	1
829200	TopFix Osteotomy Chisel, width 25mm	1

Please contact your sales representative for final product list.

TopFix Osteotomy Instruments set



898165



898193

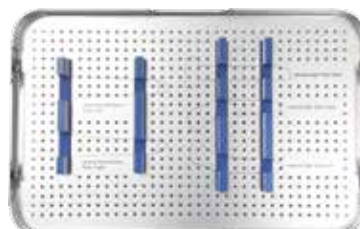



Instruments



829100
TopFix Guiding Block for Medial High Tibia



226230
TopFix Guiding Block for Lateral High Tibia, left



226240
TopFix Guiding Block for Lateral High Tibia, right



829130
TopFix Guiding Block for Lateral Distal Femur, left



829140
TopFix Guiding Block for Lateral Distal Femur, right



829150
TopFix Osteotomy Gap Measuring Device



829160
Bone Spreader with 8mm blade, medium handle, soft ratchet



829170
TopFix Osteotomy Chisel, width 10mm



829180
TopFix Osteotomy Chisel, width 15mm



829190
TopFix Osteotomy Chisel, width 20mm



829200
TopFix Osteotomy Chisel, width 25mm

MIS Instruments Set

Code	Product Description	Qty
276900	MIS Instruments Set	
898349	MIS Instruments Set(Empty)-PPSU	1
276100	MIS Insertion Guide for Distal Femur, left	1
276110	MIS Insertion Guide for Distal Femur, right	1
276120	MIS Insertion Guide for Proximal Tibia, left	1
276130	MIS Insertion Guide for Proximal Tibia, right	1
276140	Stopper	10
276150	Drill Sleeve	3
276160	Trocar	1
276170	Centering Sleeve for Kirschner Wire	3
276180	Stabilization Bolt	3
276190	Tension Device	1
276200	Screwdriver shaft 3.5	1
276210	Cleaning Driver	1
276220	Cleaning Sleeve	1
276230	Measuring Device for Kirschner Wires 2.0	1
276240	Fixation Bolt for MIS Insertion Guide	1
10737280	Threaded pins, 2.0X280mm	3
226151	Torque-limiting Screwdriver, T25	1
276250	X-ray Calibrator	1
221180	Allen Key	1
276260	Drill Bit with Stop, Φ 4.1mm	2
276270	Drill Sleeve 4.1	3
276280	Centering Sleeve for Kirschner Wire	2
276290	Aiming Device for kirschner Wire	1

Please contact your sales representative for final product list.



MIS Instruments Set



276900

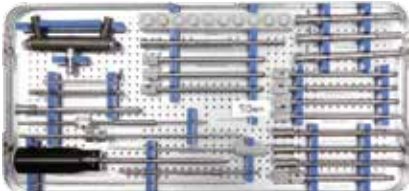



Instruments



276100/276110
MIS Insertion Guide for Distal Femur,
left/right



276120/276130
MIS Insertion Guide for Proximal Tibia,
left/right



276140
Stopper



276150
Drill Sleeve



276160
Trocar



276170
Centering Sleeve for Kirschner Wire



276180
Stabilization Bolt



276190
Tension Device



276200
Screwdriver shaft 3.5



276210
Cleaning Driver



276220
Cleaning Sleeve



276230
Measuring Device for Kirschner
Wires 2.0



276240
Fixation Bolt for MIS Insertion Guide



10737280
Threaded pins, 2.0X280mm



226151
Torque-limiting Screwdriver, T25

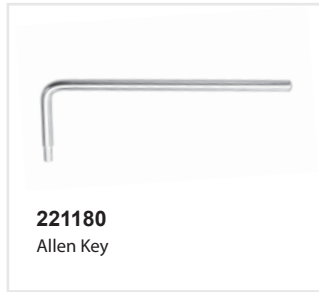
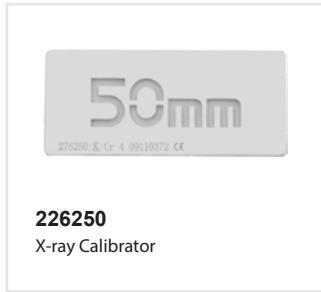



Proximal Humeral Targeting LCP Instruments Set

Code	Product Description	Qty
898427	Proximal Humeral Targeting LCP Instruments Set	
898428	Proximal Humeral Targeting LCP Instrument Set (empty)	1
281100	Proximal Aiming Block	1
281110	Screw Sleeve	2
281120	Drill Bit Sleeve	2
281130	K-Wire Sleeve	2
281140	Depth Gauge	1
281150	Screwdriver	1

Notice:

To implant targeting proximal Humeral LCP plates, MonoLoc 3.5 instruments should be used together with the above instruments.

Please contact your sales representative for final product list.



Instruments

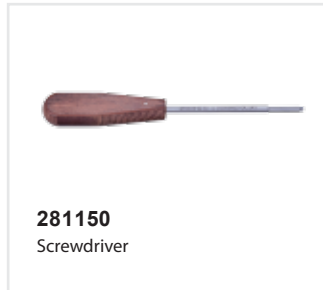



Distal Femoral and Proximal Tibia Targeting LCP Instruments Set

Code	Product Description	Qty
898429	Distal Femoral and Proximal Tibia Targeting LCP Instruments Set	
898430	Distal Femoral and Proximal Tibia Targeting LCP Instruments Set (empty)	1
226210	Targeting Distal Femoral LCP Aiming Device, left	1
226220	Targeting Distal Femoral LCP Aiming Device, right	1
226230	Targeting Proximal Tibia LCP Aiming Device, left	1
226240	Targeting Proximal Tibia LCP Aiming Device, right	1

Notice:

To implant distal femoral and proximal tibia targeting LCP plates, MonoLoc 5.0 instruments should be used together with the above instruments.

Please contact your sales representative for final product list.



Instruments



DHS/DCS System

- DHS/DCS
- Locking DHS/DCS

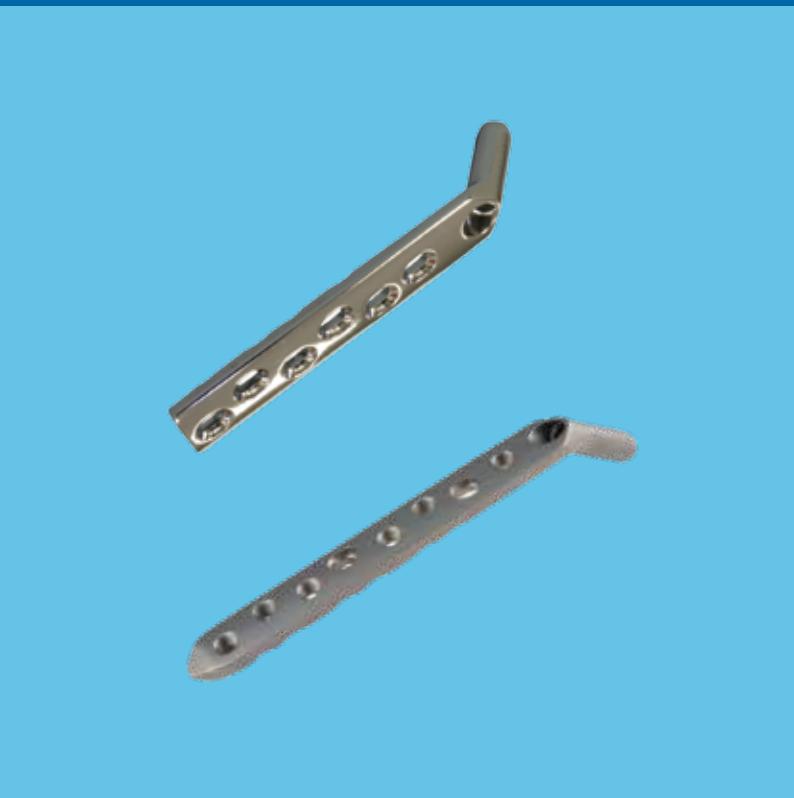

DHS/DCS

D.H.S. Plates, 135°



Product No.	Size	Material	Model No.
30170003	3H	TA	DHS IV
30170004	4H	TA	DHS IV
30170005	5H	TA	DHS IV
30170006	6H	TA	DHS IV
30170008	8H	TA	DHS IV
30170010	10H	TA	DHS IV
30170012	12H	TA	DHS IV
30170014	14H	TA	DHS IV

D.C.S. Plates, 95°



Product No.	Size	Material	Model No.
30810004	4H	TA	DCS II
30810005	5H	TA	DCS II
30810006	6H	TA	DCS II
30810008	8H	TA	DCS II
30810010	10H	TA	DCS II
30810011	11H	TA	DCS II
30810012	12H	TA	DCS II
30810014	14H	TA	DCS II



Locking DHS/DCS

Locking D.H.S. Plates , 135°



Product No.	Size	Material	Model No.
39538003	3H	TA	SDDG26
39538004	4H	TA	SDDG26
39538006	6H	TA	SDDG26
39538008	8H	TA	SDDG26
39538010	10H	TA	SDDG26
39538012	12H	TA	SDDG26
39538014	14H	TA	SDDG26

Locking D.C.S. Plates , 95°



Product No.	Size	Material	Model No.
39537904	4H	TA	SDDG28
39537905	5H	TA	SDDG28
39537906	6H	TA	SDDG28
39537908	8H	TA	SDDG28
39537910	10H	TA	SDDG28
39537912	12H	TA	SDDG28
39537914	14H	TA	SDDG28



D.H.S./D.C.S. Lag Screws



Product No.	Size	Material	Model No.
33010050	12×50mm	TA	DHS/DCS
33010055	12×55mm	TA	DHS/DCS
33010060	12×60mm	TA	DHS/DCS
33010065	12×65mm	TA	DHS/DCS
33010070	12×70mm	TA	DHS/DCS
33010075	12×75mm	TA	DHS/DCS
33010080	12×80mm	TA	DHS/DCS
33010085	12×85mm	TA	DHS/DCS
33010090	12×90mm	TA	DHS/DCS
33010092	12×95mm	TA	DHS/DCS
33010094	12×100mm	TA	DHS/DCS
33010096	12×105mm	TA	DHS/DCS
33010098	12×110mm	TA	DHS/DCS
33010100	12×115mm	TA	DHS/DCS
33010102	12×120mm	TA	DHS/DCS

D.H.S./D.C.S. Compression Screw



Product No.	Size	Material	Model No.
33011036	4×36mm	TA	DHS/DCS



DHS/DCS Instruments Set

Code	Product Description	Qty
899310	DHS/DCS Instruments Set	
898355	DHS/DCS Instruments Set (Empty)-PPSU	1
010020	Drill Bit, Φ 3.2mm	2
010040	Drill Bit, Φ 4.5mm	2
020030	Tap, Φ 4.5mm	1
020040	Tap, Φ 6.5mm	1
030100	T-Handle with Quick Coupling	1
030020	T-Handle with Quick Coupling (Large)	1
206170	Depth Gauge, 90mm	1
211120	Depth Gauge, 200mm	1
206280	Hex Screwdriver	1
206300	Screw Holding Sleeve for Hex Screw	1
211100	DCS Angled Guide, 95°	1
211110	DHS Angled Guide, 135°	1
211130	DCS Triple Reamer	1
211140	DHS Triple Reamer	1
211310	Centering Sleeve DHS/DCS, short	1
206140	Easyout	1
211160	Tap for DHS/DCS Screws, length 220mm	1
211260	Double Drill Sleeve 3.2	1
211180	Coupling Shaft	1
211170	DHS/DCS Wrench, for Removal of DHS/DCS Screws	1
211340	DHS/DCS Impactor	1
211190	DHS/DCS Impactor	1
10727230	Threaded Pin, 2.5x230mm	3
10737230	Kirschner Wire, Φ 2.0mm	2
211150	Kirschner Wire, removable	1
211330	Centering Sleeve DHS/DCS, long	1
206240	Trephine	1
211350	DHS/DCS Wrench, for DHS/DCS Screws in Titanium Alloy	1
20657	Drill Bit, Φ 2.0mm, with Quick Coupling	2
206110	Double Drill Guide 6.5/3.2	1



Code	Product Description	Qty
206120	Double Drill Guide 4.5/3.2	1
211211	Cannulated Contacting Screw	1
226100	Drill Guide 4.1	3
226110	Drill Bit with Stop, Φ 4.1mm	3
226120	Guide Sleeve for K-Wire, Φ 2.0mm	1
226140	Screw Holding Sleeve for StarDrive Screw	1
226151	Torque-limiting Screwdriver, T25	1
226160	Screwdriver, self-retaining	1
226170	Extraction Screw, Φ 5.0mm	1
221180	Allen Key	1
226190	Drill Bit for Screw Head Removal	1
226200	Torx Screwdriver, with Quick Coupling	1
10737230	Kirschner Wire, Φ 2.0mm	3

Please contact your sales representative for final product list.



DHS/DCS Instruments Set



899310

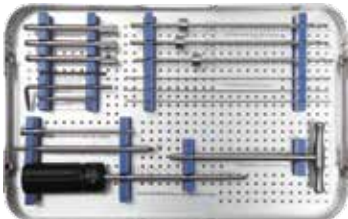
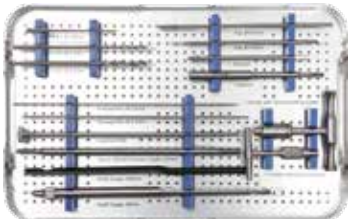



Instruments

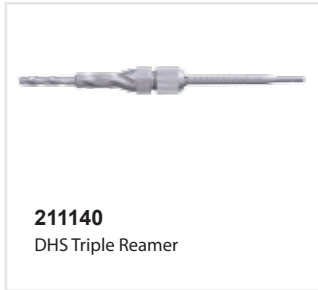
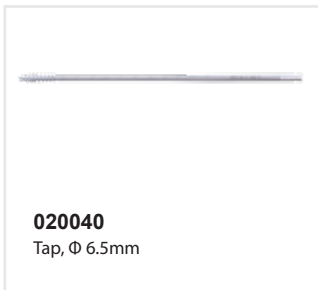
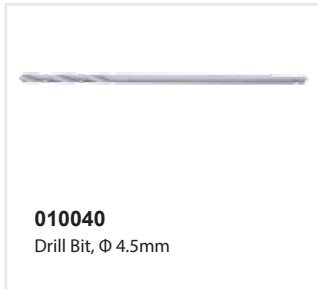

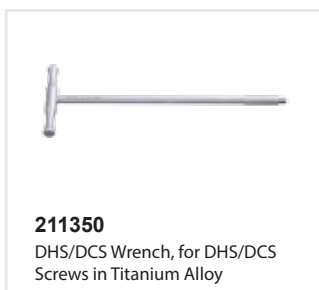
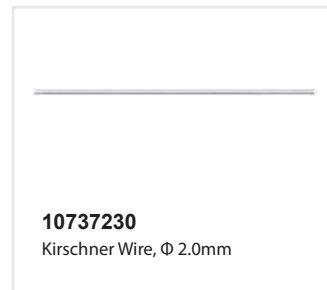
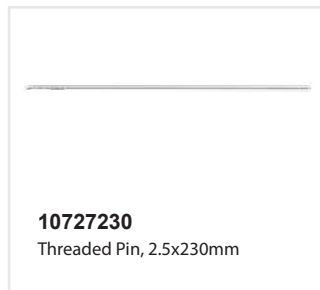

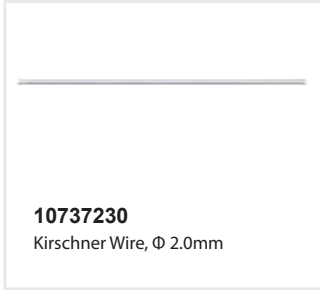
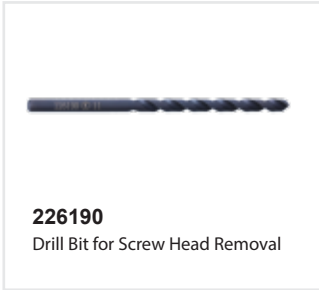
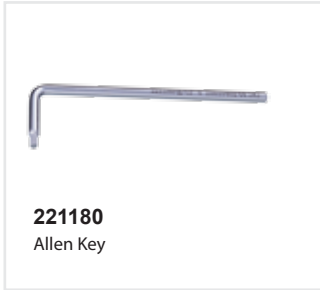
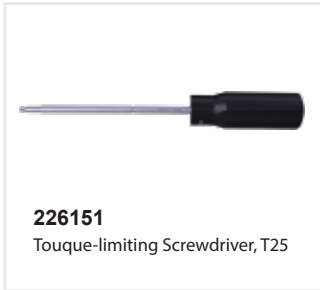
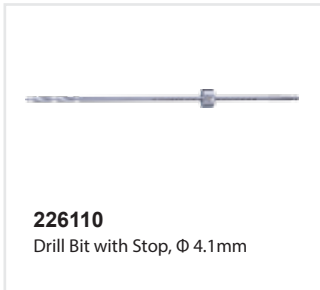
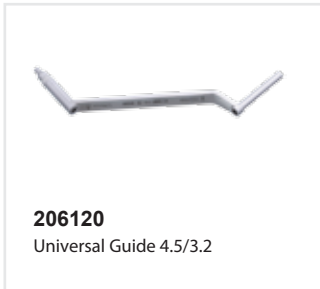

Screws & Washers System

- Screws
- Washers

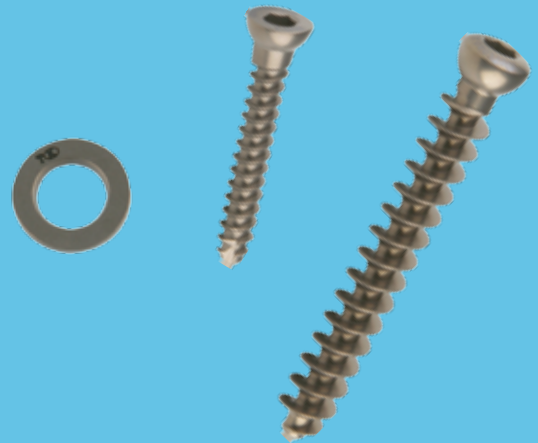

3.5mm Cortex Screw,fully threaded



Product No.	Size	Material	Model No.
30306110	3.5x10mm	TA	HAQ03
30306112	3.5x12mm	TA	HAQ03
30306114	3.5x14mm	TA	HAQ03
30306116	3.5x16mm	TA	HAQ03
30306118	3.5x18mm	TA	HAQ03
30306120	3.5x20mm	TA	HAQ03
30306122	3.5x22mm	TA	HAQ03
30306124	3.5x24mm	TA	HAQ03
30306126	3.5x26mm	TA	HAQ03
30306128	3.5x28mm	TA	HAQ03
30306130	3.5x30mm	TA	HAQ03
30306132	3.5x32mm	TA	HAQ03
30306134	3.5x34mm	TA	HAQ03
30306136	3.5x36mm	TA	HAQ03
30306138	3.5x38mm	TA	HAQ03
30306140	3.5x40mm	TA	HAQ03
30306145	3.5x45mm	TA	HAQ03
30306150	3.5x50mm	TA	HAQ03

3.5mm Cortex Screws,partially threaded



Product No.	Size	Material	Model No.
30306212	3.5x12mm	TA	HAQ03
30306214	3.5x14mm	TA	HAQ03
30306216	3.5x16mm	TA	HAQ03
30306218	3.5x18mm	TA	HAQ03
30306220	3.5x20mm	TA	HAQ03
30306222	3.5x22mm	TA	HAQ03
30306224	3.5x24mm	TA	HAQ03
30306226	3.5x26mm	TA	HAQ03

Product No.	Size	Material	Model No.
30306228	3.5x28mm	TA	HAQ03
30306230	3.5x30mm	TA	HAQ03
30306232	3.5x32mm	TA	HAQ03
30306234	3.5x34mm	TA	HAQ03
30306236	3.5x36mm	TA	HAQ03
30306238	3.5x38mm	TA	HAQ03
30306240	3.5x40mm	TA	HAQ03

4.5mm Cortex Screw, fully threaded



Product No.	Size	Material	Model No.
30308116	4.5x16mm	TA	HAQ03
30308118	4.5x18mm	TA	HAQ03
30308120	4.5x20mm	TA	HAQ03
30308122	4.5x22mm	TA	HAQ03
30308124	4.5x24mm	TA	HAQ03
30308126	4.5x26mm	TA	HAQ03
30308128	4.5x28mm	TA	HAQ03
30308130	4.5x30mm	TA	HAQ03
30308132	4.5x32mm	TA	HAQ03
30308134	4.5x34mm	TA	HAQ03
30308136	4.5x36mm	TA	HAQ03
30308138	4.5x38mm	TA	HAQ03
30308140	4.5x40mm	TA	HAQ03
30308142	4.5x42mm	TA	HAQ03
30308144	4.5x44mm	TA	HAQ03
30308146	4.5x46mm	TA	HAQ03
30308148	4.5x48mm	TA	HAQ03
30308150	4.5x50mm	TA	HAQ03
30308152	4.5x52mm	TA	HAQ03
30308154	4.5x54mm	TA	HAQ03
30308156	4.5x56mm	TA	HAQ03
30308158	4.5x58mm	TA	HAQ03
30308160	4.5x60mm	TA	HAQ03

4.5mm Cortex Screw, partially threaded



Product No.	Size	Material	Model No.
30308220	4.5x20mm	TA	HAQ03
30308222	4.5x22mm	TA	HAQ03
30308224	4.5x24mm	TA	HAQ03
30308226	4.5x26mm	TA	HAQ03
30308228	4.5x28mm	TA	HAQ03
30308230	4.5x30mm	TA	HAQ03
30308232	4.5x32mm	TA	HAQ03
30308234	4.5x34mm	TA	HAQ03
30308236	4.5x36mm	TA	HAQ03
30308238	4.5x38mm	TA	HAQ03
30308240	4.5x40mm	TA	HAQ03
30308242	4.5x42mm	TA	HAQ03
30308244	4.5x44mm	TA	HAQ03
30308246	4.5x46mm	TA	HAQ03
30308248	4.5x48mm	TA	HAQ03
30308250	4.5x50mm	TA	HAQ03
30308252	4.5x52mm	TA	HAQ03
30308254	4.5x54mm	TA	HAQ03
30308256	4.5x56mm	TA	HAQ03
30308258	4.5x58mm	TA	HAQ03
30308260	4.5x60mm	TA	HAQ03

4.0mm Cancellous Screw, fully threaded



Product No.	Size	Material	Model No.
30403110	4.0x10mm	TA	HBQ03
30403112	4.0x12mm	TA	HBQ03
30403114	4.0x14mm	TA	HBQ03

Product No.	Size	Material	Model No.
30403116	4.0x16mm	TA	HBQ03
30403118	4.0x18mm	TA	HBQ03
30403120	4.0x20mm	TA	HBQ03
30403122	4.0x22mm	TA	HBQ03
30403124	4.0x24mm	TA	HBQ03
30403126	4.0x26mm	TA	HBQ03
30403128	4.0x28mm	TA	HBQ03
30403130	4.0x30mm	TA	HBQ03
30403132	4.0x32mm	TA	HBQ03
30403134	4.0x34mm	TA	HBQ03
30403136	4.0x36mm	TA	HBQ03
30403138	4.0x38mm	TA	HBQ03
30403140	4.0x40mm	TA	HBQ03
30403142	4.0x42mm	TA	HBQ03
30403144	4.0x44mm	TA	HBQ03
30403146	4.0x46mm	TA	HBQ03
30403148	4.0x48mm	TA	HBQ03
30403150	4.0x50mm	TA	HBQ03
30403152	4.0x52mm	TA	HBQ03
30403155	4.0x55mm	TA	HBQ03
30403156	4.0x56mm	TA	HBQ03
30403160	4.0x60mm	TA	HBQ03
30403165	4.0x65mm	TA	HBQ03
30403170	4.0x70mm	TA	HBQ03

4.0mm Cancellous Screw, partially threaded



Product No.	Size	Material	Model No.
30403210	4.0x10mm	TA	HBQ03
30403212	4.0x12mm	TA	HBQ03
30403214	4.0x14mm	TA	HBQ03
30403216	4.0x16mm	TA	HBQ03
30403218	4.0x18mm	TA	HBQ03
30403220	4.0x20mm	TA	HBQ03
30403222	4.0x22mm	TA	HBQ03
30403224	4.0x24mm	TA	HBQ03
30403226	4.0x26mm	TA	HBQ03

Product No.	Size	Material	Model No.
30403228	4.0x28mm	TA	HBQ03
30403230	4.0x30mm	TA	HBQ03
30403232	4.0x32mm	TA	HBQ03
30403234	4.0x34mm	TA	HBQ03
30403236	4.0x36mm	TA	HBQ03
30403238	4.0x38mm	TA	HBQ03
30403240	4.0x40mm	TA	HBQ03
30403242	4.0x42mm	TA	HBQ03
30403244	4.0x44mm	TA	HBQ03
30403246	4.0x46mm	TA	HBQ03
30403248	4.0x48mm	TA	HBQ03
30403250	4.0x50mm	TA	HBQ03
30403252	4.0x52mm	TA	HBQ03
30403254	4.0x54mm	TA	HBQ03
30403255	4.0x55mm	TA	HBQ03
30403256	4.0x56mm	TA	HBQ03
30403260	4.0x60mm	TA	HBQ03
30403265	4.0x65mm	TA	HBQ03

6.5mm Cancellous Screw,fully threaded



Product No.	Size	Material	Model No.
30405125	6.5x25mm	TA	HBQ03
30405130	6.5x30mm	TA	HBQ03
30405135	6.5x35mm	TA	HBQ03
30405140	6.5x40mm	TA	HBQ03
30405145	6.5x45mm	TA	HBQ03
30405150	6.5x50mm	TA	HBQ03
30405155	6.5x55mm	TA	HBQ03
30405160	6.5x60mm	TA	HBQ03
30405165	6.5x65mm	TA	HBQ03
30405170	6.5x70mm	TA	HBQ03
30405175	6.5x75mm	TA	HBQ03
30405180	6.5x80mm	TA	HBQ03
30405185	6.5x85mm	TA	HBQ03
30405190	6.5x90mm	TA	HBQ03

Product No.	Size	Material	Model No.
30405191	6.5x95mm	TA	HBQ03
30405192	6.5x100mm	TA	HBQ03
30405193	6.5x105mm	TA	HBQ03
30405194	6.5x110mm	TA	HBQ03
30405195	6.5x115mm	TA	HBQ03
30405196	6.5x120mm	TA	HBQ03

6.5mm Cancellous Screw, partially threaded



Product No.	Size	Thread	Material	Model No.
30406235	6.5x35mm	16mm	TA	HBQ03
30406240	6.5x40mm	16mm	TA	HBQ03
30406245	6.5x45mm	16mm	TA	HBQ03
30406250	6.5x50mm	16mm	TA	HBQ03
30406255	6.5x55mm	16mm	TA	HBQ03
30406260	6.5x60mm	16mm	TA	HBQ03
30406265	6.5x65mm	16mm	TA	HBQ03
30406270	6.5x70mm	16mm	TA	HBQ03
30406275	6.5x75mm	16mm	TA	HBQ03
30406280	6.5x80mm	16mm	TA	HBQ03
30406285	6.5x85mm	16mm	TA	HBQ03
30406290	6.5x90mm	16mm	TA	HBQ03
30406291	6.5x95mm	16mm	TA	HBQ03
30406292	6.5x100mm	16mm	TA	HBQ03
30406293	6.5x105mm	16mm	TA	HBQ03
30406294	6.5x110mm	16mm	TA	HBQ03
30406295	6.5x115mm	16mm	TA	HBQ03
30406296	6.5x120mm	16mm	TA	HBQ03
30407240	6.5x40mm	32mm	TA	HBQ03
30407245	6.5x45mm	32mm	TA	HBQ03
30407250	6.5x50mm	32mm	TA	HBQ03
30407255	6.5x55mm	32mm	TA	HBQ03

Product No.	Size	Thread	Material	Model No.
30407260	6.5x60mm	32mm	TA	HBQ03
30407265	6.5x65mm	32mm	TA	HBQ03
30407270	6.5x70mm	32mm	TA	HBQ03
30407275	6.5x75mm	32mm	TA	HBQ03
30407280	6.5x80mm	32mm	TA	HBQ03
30407285	6.5x85mm	32mm	TA	HBQ03
30407290	6.5x90mm	32mm	TA	HBQ03
30407291	6.5x95mm	32mm	TA	HBQ03
30408292	6.5x100mm	32mm	TA	HBQ03
30407293	6.5x105mm	32mm	TA	HBQ03
30407294	6.5x110mm	32mm	TA	HBQ03

3.5mm Cortex Screw,fully threaded,self tapping



Product No.	Size	Material	Model No.
39513510	3.5x10mm	TA	HAQ03
39513512	3.5x12mm	TA	HAQ03
39513514	3.5x14mm	TA	HAQ03
39513516	3.5x16mm	TA	HAQ03
39513518	3.5x18mm	TA	HAQ03
39513520	3.5x20mm	TA	HAQ03
39513522	3.5x22mm	TA	HAQ03
39513524	3.5x24mm	TA	HAQ03
39513526	3.5x26mm	TA	HAQ03
39513528	3.5x28mm	TA	HAQ03
39513530	3.5x30mm	TA	HAQ03
39513532	3.5x32mm	TA	HAQ03
39513534	3.5x34mm	TA	HAQ03
39513536	3.5x36mm	TA	HAQ03
39513538	3.5x38mm	TA	HAQ03
39513540	3.5x40mm	TA	HAQ03
39513542	3.5x42mm	TA	HAQ03
39513544	3.5x44mm	TA	HAQ03
39513545	3.5x45mm	TA	HAQ03

Product No.	Size	Material	Model No.
39513546	3.5x46mm	TA	HAQ03
39513548	3.5x48mm	TA	HAQ03
39513550	3.5x50mm	TA	HAQ03
39513555	3.5x55mm	TA	HAQ03
39513560	3.5x60mm	TA	HAQ03
39513565	3.5x65mm	TA	HAQ03
39513570	3.5x70mm	TA	HAQ03

4.5mm Cortex Screw, fully threaded, self tapping



Product No.	Size	Material	Model No.
39527914	4.5x14mm	TA	HAQ03
39527916	4.5x16mm	TA	HAQ03
39527918	4.5x18mm	TA	HAQ03
39527920	4.5x20mm	TA	HAQ03
39527922	4.5x22mm	TA	HAQ03
39527924	4.5x24mm	TA	HAQ03
39527926	4.5x26mm	TA	HAQ03
39527928	4.5x28mm	TA	HAQ03
39527930	4.5x30mm	TA	HAQ03
39527932	4.5x32mm	TA	HAQ03
39527934	4.5x34mm	TA	HAQ03
39527936	4.5x36mm	TA	HAQ03
39527938	4.5x38mm	TA	HAQ03
39527940	4.5x40mm	TA	HAQ03
39527942	4.5x42mm	TA	HAQ03
39527944	4.5x44mm	TA	HAQ03
39527946	4.5x46mm	TA	HAQ03
39527948	4.5x48mm	TA	HAQ03
39527950	4.5x50mm	TA	HAQ03
39527952	4.5x52mm	TA	HAQ03
39527954	4.5x54mm	TA	HAQ03
39527956	4.5x56mm	TA	HAQ03
39527958	4.5x58mm	TA	HAQ03
39527960	4.5x60mm	TA	HAQ03
39527965	4.5x65mm	TA	HAQ03
39527970	4.5x70mm	TA	HAQ03
39527975	4.5x75mm	TA	HAQ03



Washers



Product No.	Size	Material	Model No.
31409000	Washer for 4.0 Cancellous Screws	TA	DJY-II
31410000	Washer for 6.5 Cancellous Screws	TA	DJY-II
39781000	Washer for 6.5 Cancellous Screws, notched	TA	DJY-II-02
31406000	Washer for 4.5 Cannulated Screws	TA	DJY-II
31407000	Washer for 4.5 Cannulated Screws,notched	TA	DJY-II
31402000	Washer for 7.3 Cannulated Screws	TA	DJY-II
31403000	Washer for 7.3 Cannulated Screws,notched	TA	DJY-II

Cannulated Screws System

- KCS 4.0/4.5/7.0/7.3

- HCS 2.4/3.0mm Headless Compression Screw



KCS 4.0/4.5/7.0/7.3

4.0mm Cannulated Screws



Product No.	Size	Material	Model No.
31421025	4.0×25mm	TA	DJY-II
31421030	4.0×30mm	TA	DJY-II
31421035	4.0×35mm	TA	DJY-II
31421040	4.0×40mm	TA	DJY-II
31421045	4.0×45mm	TA	DJY-II
31421050	4.0×50mm	TA	DJY-II
31421055	4.0×55mm	TA	DJY-II
31421060	4.0×60mm	TA	DJY-II
31421065	4.0×65mm	TA	DJY-II
31421070	4.0×70mm	TA	DJY-II

4.5mm Cannulated Screws



Product No.	Size	Material	Model No.
31405020	4.5x 20mm	TA	DJY-II
31405025	4.5× 25mm	TA	DJY-II
31405030	4.5× 30mm	TA	DJY-II
31405035	4.5× 35mm	TA	DJY-II
31405040	4.5× 40mm	TA	DJY-II
31405045	4.5× 45mm	TA	DJY-II
31405050	4.5× 50mm	TA	DJY-II
31405055	4.5× 55mm	TA	DJY-II
31405060	4.5× 60mm	TA	DJY-II
31405065	4.5× 65mm	TA	DJY-II
31405070	4.5× 70mm	TA	DJY-II
31405075	4.5× 75mm	TA	DJY-II



7.0mm Cannulated Screws



Product No.	Size	Material	Model No.
31411040	7.0× 40mm	TA	DJY-II
31411045	7.0× 45mm	TA	DJY-II
31411050	7.0× 50mm	TA	DJY-II
31411055	7.0× 55mm	TA	DJY-II
31411060	7.0× 60mm	TA	DJY-II
31411065	7.0× 65mm	TA	DJY-II
31411070	7.0× 70mm	TA	DJY-II
31411075	7.0× 75mm	TA	DJY-II
31411080	7.0× 80mm	TA	DJY-II
31411085	7.0× 85mm	TA	DJY-II
31411090	7.0× 90mm	TA	DJY-II
31411091	7.0× 95mm	TA	DJY-II
31411092	7.0× 100mm	TA	DJY-II
31411093	7.0× 105mm	TA	DJY-II

7.3mm Cannulated Screws, 16mm thread



Product No.	Size	Material	Model No.
31401040	7.3×40mm	TA	DJY-II
31401045	7.3×45mm	TA	DJY-II
31401050	7.3×50mm	TA	DJY-II
31401055	7.3×55mm	TA	DJY-II
31401060	7.3×60mm	TA	DJY-II
31401065	7.3×65mm	TA	DJY-II
31401070	7.3×70mm	TA	DJY-II
31401075	7.3×75mm	TA	DJY-II

Product No.	Size	Material	Model No.
31401080	7.3×80mm	TA	DJY-II
31401085	7.3×85mm	TA	DJY-II
31401090	7.3×90mm	TA	DJY-II
31401091	7.3×95mm	TA	DJY-II
31401092	7.3×100mm	TA	DJY-II
31401093	7.3×105mm	TA	DJY-II
31401094	7.3×110mm	TA	DJY-II
31401095	7.3×115mm	TA	DJY-II
31401096	7.3×120mm	TA	DJY-II

7.3mm Cannulated Screws, 32mm thread



Product No.	Size	Material	Model No.
31404050	7.3×50mm	TA	DJY-II
31404055	7.3×55mm	TA	DJY-II
31404060	7.3×60mm	TA	DJY-II
31404065	7.3×65mm	TA	DJY-II
31404070	7.3×70mm	TA	DJY-II
31404075	7.3×75mm	TA	DJY-II
31404080	7.3×80mm	TA	DJY-II
31404085	7.3×85mm	TA	DJY-II
31404090	7.3×90mm	TA	DJY-II
31404091	7.3×95mm	TA	DJY-II
31404092	7.3×100mm	TA	DJY-II
31404093	7.3×105mm	TA	DJY-II
31404094	7.3×110mm	TA	DJY-II
31404095	7.3×115mm	TA	DJY-II
31404096	7.3×120mm	TA	DJY-II

2.4/3.0mm Headless Compression Screws system

2.4mm Headless Compression Screws, short thread



Product No.	Size	Material	Model No.
31462009	9mm	TA	DJY-III
31462010	10mm	TA	DJY-III
31462011	11mm	TA	DJY-III
31462012	12mm	TA	DJY-III
31462013	13mm	TA	DJY-III
31462014	14mm	TA	DJY-III
31462015	15mm	TA	DJY-III
31462016	16mm	TA	DJY-III
31462017	17mm	TA	DJY-III
31462018	18mm	TA	DJY-III
31462019	19mm	TA	DJY-III
31462020	20mm	TA	DJY-III
31462021	21mm	TA	DJY-III
31462022	22mm	TA	DJY-III
31462023	23mm	TA	DJY-III
31462024	24mm	TA	DJY-III
31462025	25mm	TA	DJY-III
31462026	26mm	TA	DJY-III
31462027	27mm	TA	DJY-III
31462028	28mm	TA	DJY-III
31462029	29mm	TA	DJY-III
31462030	30mm	TA	DJY-III
31462032	32mm	TA	DJY-III
31462034	34mm	TA	DJY-III
31462036	36mm	TA	DJY-III
31462038	38mm	TA	DJY-III
31462040	40mm	TA	DJY-III

2.4mm Headless Compression Screws, long thread



Product No.	Size	Material	Model No.
31463017	17mm	TA	DJY-III
31463018	18mm	TA	DJY-III
31463019	19mm	TA	DJY-III
31463020	20mm	TA	DJY-III
31463021	21mm	TA	DJY-III
31463022	22mm	TA	DJY-III
31463023	23mm	TA	DJY-III
31463024	24mm	TA	DJY-III
31463025	25mm	TA	DJY-III
31463026	26mm	TA	DJY-III
31463027	27mm	TA	DJY-III
31463028	28mm	TA	DJY-III
31463029	29mm	TA	DJY-III
31463030	30mm	TA	DJY-III
31463032	32mm	TA	DJY-III
31463034	34mm	TA	DJY-III
31463036	36mm	TA	DJY-III
31463038	38mm	TA	DJY-III
31463040	40mm	TA	DJY-III

3.0mm Headless Compression Screws, short thread



Product No.	Size	Material	Model No.
31464010	10mm	TA	DJY-III
31464011	11mm	TA	DJY-III
31464012	12mm	TA	DJY-III
31464013	13mm	TA	DJY-III
31464014	14mm	TA	DJY-III
31464015	15mm	TA	DJY-III
31464016	16mm	TA	DJY-III
31464017	17mm	TA	DJY-III

Product No.	Size	Material	Model No.
31464018	18mm	TA	DJY-III
31464019	19mm	TA	DJY-III
31464020	20mm	TA	DJY-III
31464021	21mm	TA	DJY-III
31464022	22mm	TA	DJY-III
31464023	23mm	TA	DJY-III
31464024	24mm	TA	DJY-III
31464025	25mm	TA	DJY-III
31464026	26mm	TA	DJY-III
31464027	27mm	TA	DJY-III
31464028	28mm	TA	DJY-III
31464029	29mm	TA	DJY-III
31464030	30mm	TA	DJY-III
31464032	32mm	TA	DJY-III
31464034	34mm	TA	DJY-III
31464036	36mm	TA	DJY-III
31464038	38mm	TA	DJY-III
31464040	40mm	TA	DJY-III

3.0mm Headless Compression Screws, long thread



Product No.	Size	Material	Model No.
31465016	16mm	TA	DJY-III
31465017	17mm	TA	DJY-III
31465018	18mm	TA	DJY-III
31465019	19mm	TA	DJY-III
31465020	20mm	TA	DJY-III
31465021	21mm	TA	DJY-III
31465022	22mm	TA	DJY-III
31465023	23mm	TA	DJY-III
31465024	24mm	TA	DJY-III
31465025	25mm	TA	DJY-III
31465026	26mm	TA	DJY-III
31465027	27mm	TA	DJY-III
31465028	28mm	TA	DJY-III
31465029	29mm	TA	DJY-III
31465030	30mm	TA	DJY-III
31465032	32mm	TA	DJY-III
31465034	34mm	TA	DJY-III
31465036	36mm	TA	DJY-III
31465038	38mm	TA	DJY-III
31465040	40mm	TA	DJY-III



4.0mm KCS Cannulated Screws Instruments Set

Code	Product Description	Qty
899900	4.0mm KCS Cannulated Screws Instruments Set	
898350	4.0mm KCS Cannulated Screws Instruments Set (Empty)-PPSU	1
246100	Cleaning Stylet, Φ 1.2mm	1
246110	Guide Wire, Φ 1.2mm	3
246120	Threaded Pin, Φ 1.2mm	3
246130	Direct Measuring Device	1
246140	Drill Guide for Guide Wire Φ 1.2mm	1
246150	Drill Sleeve 3.0	1
246160	Allen Key, for Protector	1
246170	Protector	1
246180	Cannulated Drill Bit, Φ 3.0mm	1
246190	Tap, Φ 4.0mm	1
246200	Cannulated Screwdriver	1
246210	Hex Screwdriver	1
246220	Cannulated Countersink	1
246230	Easyout	1
246240	Screw Forceps, self-retaining	1

Please contact your sales representative for final product list.

4.0mm KCS Cannulated Screws Instruments Set

















899900





Instruments

 <p>246100 Cleaning Stylet, Φ 1.2mm</p>	 <p>246110 Guide Wire, Φ 1.2mm</p>	 <p>246120 Threaded Pin, Φ 1.2mm</p>
 <p>246130 Direct Measuring Device for Guide Wire Φ 1.2mm</p>	 <p>246140 Drill Guide for Guide Wire Φ 1.2mm</p>	 <p>246150 Drill Sleeve 3.0</p>
 <p>246160 Allen Key, for Protector</p>	 <p>246170 Protector</p>	 <p>246180 Cannulated Drill Bit, Φ 3.0mm</p>
 <p>246190 Tap, Φ 4.0mm</p>	 <p>246200 Cannulated Screwdriver</p>	 <p>246210 Hex Screwdriver</p>
 <p>246220 Cannulated Countersink</p>	 <p>246230 Easyout</p>	 <p>246240 Screw Forceps, self-retaining</p>

4.5mm KCS Cannulated Screws Instruments Set

Code	Product Description	Qty
236900	4.5mm KCS Cannulated Screws Instruments Set	
898351	4.5mm KCS Cannulated Screws Instruments Set (Empty)-PPSU	1
236100	Cleaning Stylet	1
236111	Guide Wire, Φ 1.6mm	3
236121	Threaded Pin, Φ 1.6mm	3
246130	Direct Measuring Device	1
236140	Drill Guide 1.6	1
236150	Protection Sleeve	1
236160	Protector, Φ 3.2mm	1
236170	Allen Key, for Protector	1
236180	Cannulated Drill Bit, Φ 3.2mm	1
236190	Tap, Φ 4.5mm	1
236200	Cannulated Countersink	1
236210	Easyout	1
236220	Cannulated Screwdriver SW3.5	1
236230	Screw Holding Sleeve	1
236240	Hex Screwdriver SW3.5	1
236250	Screw Forceps, self-retaining	1
206120	Double Drill Guide 4.5/3.2	1

Please contact your sales representative for final product list.

4.5mm KCS Cannulated Screws Instruments Set



236900





Instruments

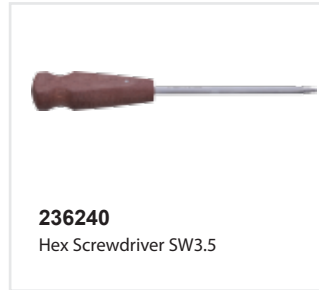
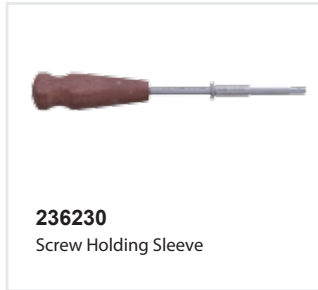
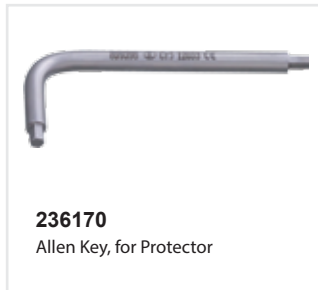
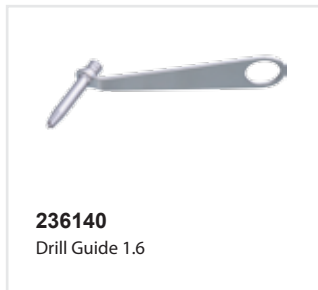
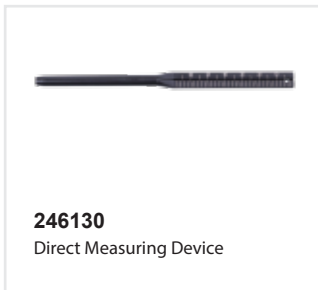
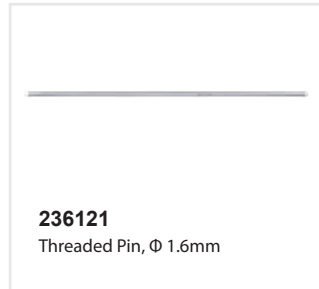
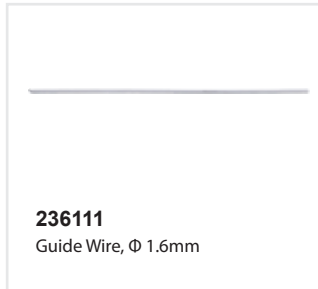
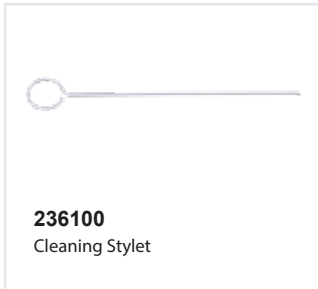



7.0mm KCS Cannulated Screws Instrument Set

Code	Product Description	Qty
899920	7.0mm KCS Cannulated Screws Instruments Set	
898352	7.0mm KCS Cannulated Screws Instruments Set (Empty)-PPSU	1
899921	Cannulated Countersink	1
899922	Cannulated Drill Bit, Φ 4.5mm	1
899923	Protection Sleeve	1
899924	Drill Sleeve 4.5/2.0	1
899925	Drill Sleeve 10.0/4.5	1
899926	Drill Sleeve 10.0/2.0	1
899927	Parallel Guide for Guide Wires Φ 2.0mm, adjustable	1
899928	Tap, Φ 7.0mm	1
899929	Allen Key, for Protector	1
899930	Cleaning Stylet	1
899931	Protector	1
899932	Drill Guide for Multiple Insertion of Guide Wires Φ 2.0mm	1
899933	Cannulated Screwdriver SW3.5	1
899934	Guide Wire, Φ 2.0mm	3
899935	Threaded Pin, Φ 2.0mm	3
899936	Screw Holding Sleeve	1
899937	Hex Screwdriver, SW3.5	1
899938	Direct Measuring Device for Guide Wire Φ 2.0mm	1

Please contact your sales representative for final product list.



7.0mm KCS Cannulated Screws Instrument Set

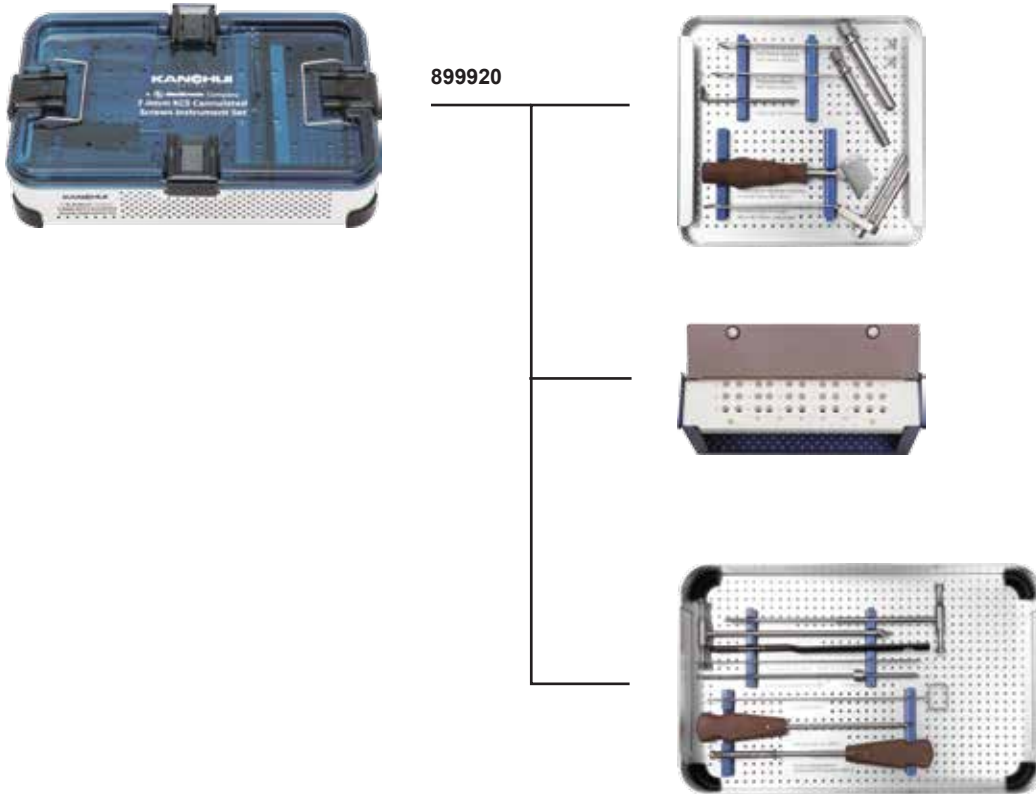

Instruments



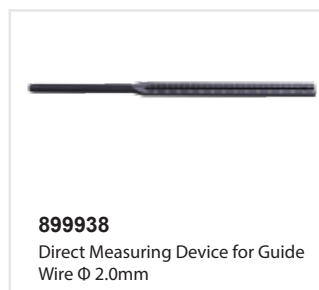
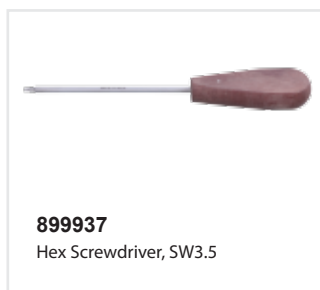
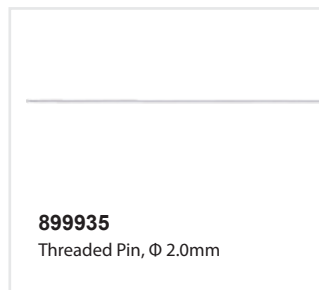
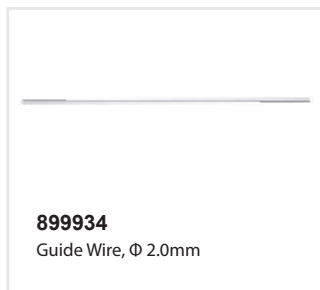
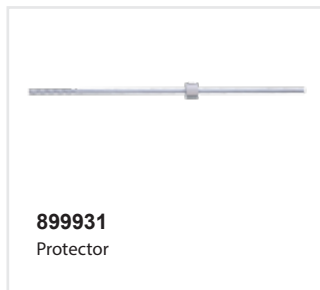
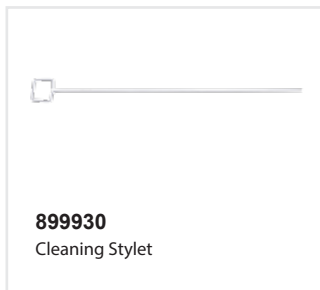
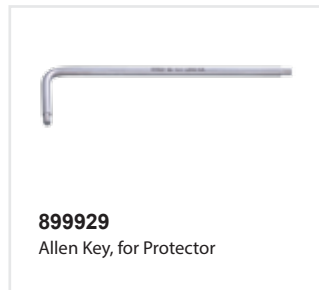
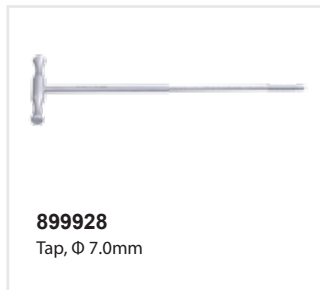
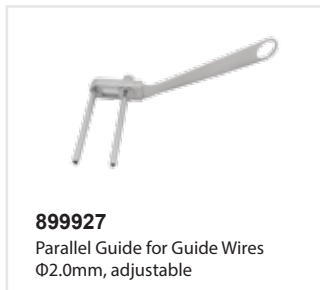
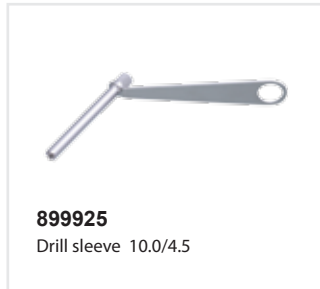
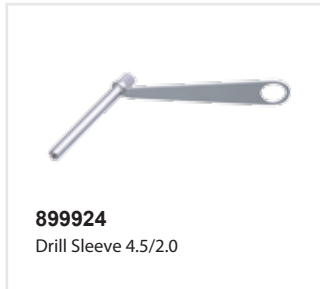



7.3mm KCS Cannulated Screws Instrument Set

Code	Product Description	Qty
241900	7.3mm KCS Cannulated Screws Instruments Set	
898353	7.3mm KCS Cannulated Screws Instruments Set (Empty)-PPSU	1
241100	Cleaning Stylet	1
241110	Trocar	1
241120	Drill Guide 2.5	1
241130	Protection Sleeve	1
241140	Protection Sleeve 10.0	1
241150	Parallel Guide for Guide Wires Φ 2.5mm, adjustable	1
241160	Cannulated Drill Bit, Φ 5.0mm	1
241170	Protector	1
241180	Allen Key, for Protector	1
241190	Tap, Φ 7.3mm	1
241200	Cannulated Countersink	1
241210	Easyout	1
241220	Drill Guide for Multiple Insertion of Guide Wires Φ 2.5mm	1
241230	Cannulated Screwdriver SW4.0	1
241240	Hex Screwdriver SW4.0	1
241250	Guide Wire, Φ 2.5mm	3
241260	Threaded Pin, Φ 2.5mm	3
241270	Direct Measuring Device for Guide Wire Φ 2.5mm	1
241280	Screw Holding Sleeve	1
241290	Pin Wrench	1

Please contact your sales representative for final product list.



7.3mm KCS Cannulated Screws Instrument Set



241900

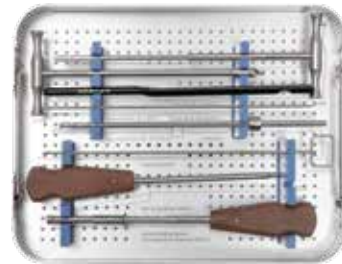

Instruments

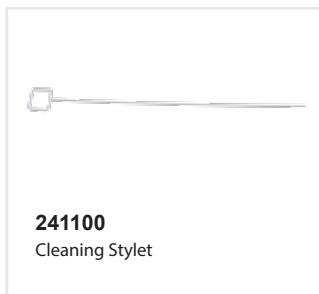

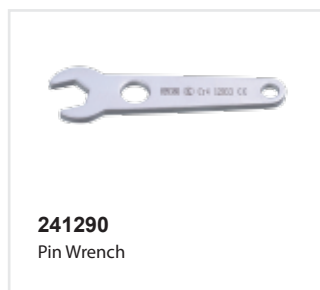
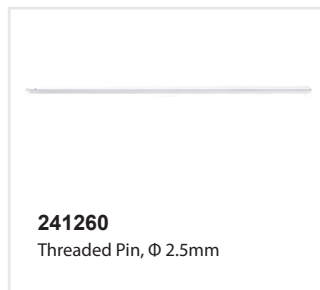
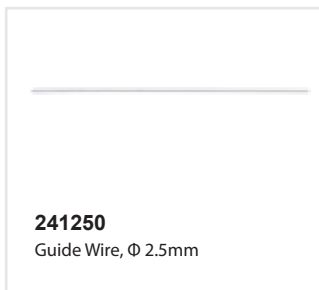
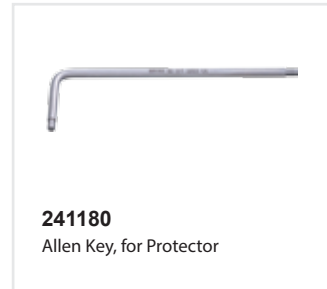

2.4/3.0 Headless Compression Screw Instruments Set

Code	Product Description	Qty
237000	2.4/3.0 Headless Compression Screws Instruments Set	
898354	2.4/3.0 Headless Compression Screws Instruments Set (Empty)-PPSU	1
237040	2.4mm HCS Implants Tray	1
237050	3.0mm HCS Implants Tray	1
237100	Compression Sleeve for Headless Compression Screw Φ 3.0mm	1
237180	Depth Gauge	1
237150	Cannulated Trapezium Drill, Quick Coupling, Φ 4.8 mm	1
237110	Cannulated StarDrive Screwdriver Shaft, T8, Quick Coupling	1
237160	Trapezium Drill Sleeve 4.8	1
237130	Compression Sleeve Handle	1
237120	Compression Sleeve for Headless Compression Screw Φ 2.4mm	1
10749150	Threaded Guide Wire, Φ 1.1mm	2
10750150	Guide Wire, Φ 1.1mm	2
237140	Cannulated Drill Bit, Quick Coupling, Φ 2.0mm	1
237200	Handle, with Quick Coupling	1
237170	Double Drill Sleeve 2.0 /1.1	1
286210	StarDrive Screwdriver Shaft, T8	1
237190	Cleaning Stylet, Φ 1.1mm	1
01220	Screw Forceps	1
01232	Periosteal Elevator, width 3mm	1
01218	Sharp Hooker	1

Please contact your sales representative for final product list.



2.4/3.0 Headless Compression Screw Instruments Set



237000



237040



237050

Instruments

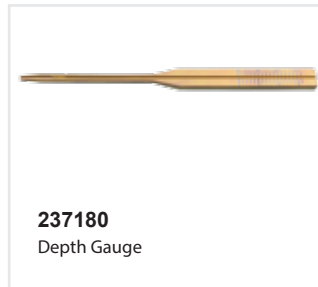

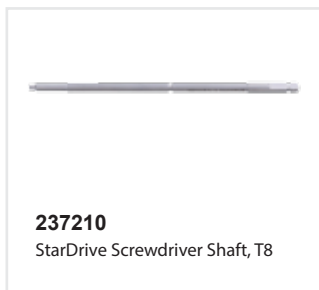
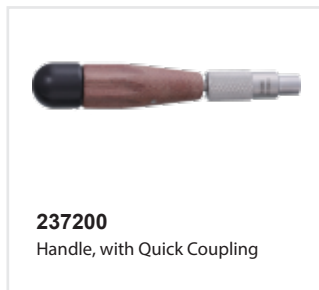
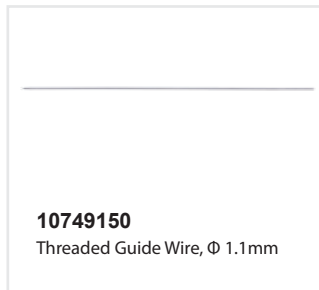
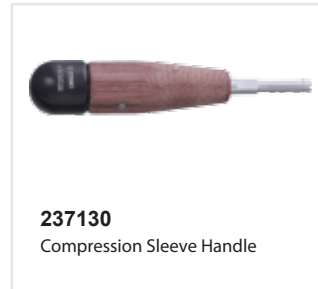
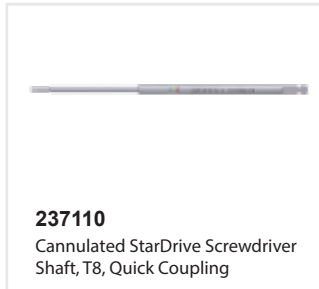

NeoGen Nails System

- NeoGen Femoral Nail/Tibia Nail/Retrograde Nail/Gamma Nail
- NeoGen AR Nail



NeoGen Femoral Nails

- *All Femoral Nails are cannulated.
- *5.0mm locking screw or 6.3mm lag screw for proximal locking
- *4.5mm locking screw for distal locking of 9.5mm and 10mm nails
- *5.0mm locking screw for distal locking of 11mm and 12mm nails



Product No.		Product No.		Size	Material	Model No.
33101232	Left	33101132	Right	9.5x320mm	TA	JSDII
33101234	Left	33101134	Right	9.5x340mm	TA	JSDII
33101236	Left	33101136	Right	9.5x360mm	TA	JSDII
33101238	Left	33101138	Right	9.5x380mm	TA	JSDII
33101240	Left	33101140	Right	9.5x400mm	TA	JSDII
33101242	Left	33101142	Right	9.5x420mm	TA	JSDII
33101244	Left	33101144	Right	9.5x440mm	TA	JSDII
33102232	Left	33102132	Right	10x320mm	TA	JSDII
33102234	Left	33102134	Right	10x340mm	TA	JSDII
33102236	Left	33102136	Right	10x360mm	TA	JSDII
33102238	Left	33102138	Right	10x380mm	TA	JSDII
33102240	Left	33102140	Right	10x400mm	TA	JSDII
33102242	Left	33102142	Right	10x420mm	TA	JSDII
33102244	Left	33102144	Right	10x440mm	TA	JSDII
33103232	Left	33103132	Right	11x320mm	TA	JSDII
33103234	Left	33103134	Right	11x340mm	TA	JSDII
33103236	Left	33103136	Right	11x360mm	TA	JSDII
33103238	Left	33103138	Right	11x380mm	TA	JSDII
33103240	Left	33103140	Right	11x400mm	TA	JSDII
33103242	Left	33103142	Right	11x420mm	TA	JSDII
33103244	Left	33103144	Right	11x440mm	TA	JSDII
33104232	Left	33104132	Right	12x320mm	TA	JSDII
33104234	Left	33104134	Right	12x340mm	TA	JSDII
33104236	Left	33104136	Right	12x360mm	TA	JSDII
33104238	Left	33104138	Right	12x380mm	TA	JSDII
33104240	Left	33104140	Right	12x400mm	TA	JSDII
33104242	Left	33104142	Right	12x420mm	TA	JSDII
33104244	Left	33104144	Right	12x440mm	TA	JSDII

NeoGen Reconstruction Locking Screws

*For Femoral Nails Recon Mode



Product No.	Size	Material	Model No.
33113065	6.3x65mm	TA	JGDVIII
33113070	6.3x70mm	TA	JGDVIII
33113075	6.3x75mm	TA	JGDVIII
33113080	6.3x80mm	TA	JGDVIII
33113085	6.3x85mm	TA	JGDVIII
33113090	6.3x90mm	TA	JGDVIII
33113091	6.3x95mm	TA	JGDVIII
33113092	6.3x100mm	TA	JGDVIII
33113093	6.3x105mm	TA	JGDVIII
33113094	6.3x110mm	TA	JGDVIII
33113095	6.3x115mm	TA	JGDVIII
33113096	6.3x120mm	TA	JGDVIII
33113097	6.3x125mm	TA	JGDVIII

NeoGen Nails Caps (Femoral)



Product No.	Size	Material	Model No.
33110000		TA	JGMV
33110005	Φ13,+5	TA	JGMV
33110010	Φ13,+10	TA	JGMV
33110015	Φ13,+15	TA	JGMV

NeoGen Tibia Nails

*5.0mm locking screw for proximal locking

*4.5mm locking screw for distal locking of 8.3mm,9mm and 10mm nails

*5.0mm locking screw for distal locking of 11.5mm nail



Product No.	Size	Material	Model No.
33140026	8.3x260mm	TA	JJDV
33140028	8.3x280mm	TA	JJDV
33140030	8.3x300mm	TA	JJDV
33140032	8.3x320mm	TA	JJDV
33140034	8.3x340mm	TA	JJDV
33140036	8.3x360mm	TA	JJDV
33140038	8.3x380mm	TA	JJDV
33140040	8.3x400mm	TA	JJDV
33140042	8.3x420mm	TA	JJDV
33141026	9x260mm	TA	JJDV
33141028	9x280mm	TA	JJDV
33141030	9x300mm	TA	JJDV
33141032	9x320mm	TA	JJDV
33141034	9x340mm	TA	JJDV
33141036	9x360mm	TA	JJDV
33141038	9x380mm	TA	JJDV
33141040	9x400mm	TA	JJDV
33141042	9x420mm	TA	JJDV
33142026	10x260mm	TA	JJDV
33142028	10x280mm	TA	JJDV
33142030	10x300mm	TA	JJDV
33142032	10x320mm	TA	JJDV
33142034	10x340mm	TA	JJDV
33142036	10x360mm	TA	JJDV
33142038	10x380mm	TA	JJDV
33142040	10x400mm	TA	JJDV
33142042	10x420mm	TA	JJDV
33143026	11.5x260mm	TA	JJDV
33143028	11.5x280mm	TA	JJDV
33143030	11.5x300mm	TA	JJDV

33143032	11.5x320mm	TA	JJDV
33143034	11.5x340mm	TA	JJDV
33143036	11.5x360mm	TA	JJDV
33143038	11.5x380mm	TA	JJDV
33143040	11.5x400mm	TA	JJDV
33143042	11.5x420mm	TA	JJDV

NeoGen Retrograde Nails

*5.0mm locking screw for distal locking

*4.5mm locking screw for distal locking of 10mm nail

*5.0mm locking screw for proximal locking of 11.5mm nail



Product No.	Size	Material	Model No.
33166260	10x260mm	TA	JGDVII
33166280	10x280mm	TA	JGDVII
33166300	10x300mm	TA	JGDVII
33166320	10x320mm	TA	JGDVII
33166340	10x340mm	TA	JGDVII
33166360	10x360mm	TA	JGDVII
33166380	10x380mm	TA	JGDVII
33166400	10x400mm	TA	JGDVII
33166420	10x420mm	TA	JGDVII
33167260	11.5x260mm	TA	JGDVII
33167280	11.5x280mm	TA	JGDVII
33167300	11.5x300mm	TA	JGDVII
33167320	11.5x320mm	TA	JGDVII
33167340	11.5x340mm	TA	JGDVII
33167360	11.5x360mm	TA	JGDVII
33167380	11.5x380mm	TA	JGDVII
33167400	11.5x400mm	TA	JGDVII
33167420	11.5x420mm	TA	JGDVII

NeoGen Nails Caps(Tibia&Retrograde)



Product No.	Size	Material	Model No.
33110000		TA	JGMV
33144005	Φ11.5,+5mm	TA	JGMV
33144010	Φ11.5,+10mm	TA	JGMV
33144015	Φ11.5,+15mm	TA	JGMV

NeoGen GAMMA Nails

*5.0mm locking screw for distal locking



Product No.	Size	Material	Model No.
33120018	11x180mm	TA	JGDIII
33120024	11x240mm	TA	JGDIII

NeoGen GAMMA Nails Lag Screws

*For Gamma Nail



Product No.	Size	Material	Model No.
33123075	10.5x75mm	TA	JSDIX
33123080	10.5x80mm	TA	JSDIX
33123085	10.5x85mm	TA	JSDIX
33123090	10.5x90mm	TA	JSDIX
33123091	10.5x95mm	TA	JSDIX
33123092	10.5x100mm	TA	JSDIX
33123093	10.5x105mm	TA	JSDIX
33123094	10.5x110mm	TA	JSDIX
33123095	10.5x120mm	TA	JSDIX

NeoGen Nails Caps (GAMMA)



Product No.	Size	Material	Model No.
33121000	Φ 10.3mm	TA	JGMV
33122005	Φ15.5,+5mm	TA	JGMV
33122010	Φ15.5,+10mm	TA	JGMV
39570815	Φ15.5,+15mm	TA	JGMV

NeoGen AR Nail

*4.5mm locking screw for distal locking of 9.3mm nail

*5.0mm locking screw for distal locking of 10mm, 11mm and 12mm nails



Product No.	Size	Material	Model No.
32805017	9.3x170mm	TA	JGDVI
32805020	9.3x200mm	TA	JGDVI
32805024	9.3x240mm	TA	JGDVI
32803017	10x170mm	TA	JGDVI
32803020	10x200mm	TA	JGDVI
32803024	10x240mm	TA	JGDVI
32804017	11x170mm	TA	JGDVI
32804020	11x200mm	TA	JGDVI
32804024	11x240mm	TA	JGDVI
39591117	12x170mm	TA	JGDVI
39591120	12x200mm	TA	JGDVI
39591124	12x240mm	TA	JGDVI

NeoGen AR Blade



Product No.	Size	Material	Model No.
32801070	10.3x70mm	TA	JSDX
32801075	10.3x75mm	TA	JSDX
32801080	10.3x80mm	TA	JSDX
32801085	10.3x85mm	TA	JSDX
32801090	10.3x90mm	TA	JSDX
32801091	10.3x95mm	TA	JSDX
32801092	10.3x100mm	TA	JSDX
32801093	10.3x105mm	TA	JSDX
32801094	10.3x110mm	TA	JSDX
32801095	10.3x115mm	TA	JSDX
32801096	10.3x120mm	TA	JSDX

End Caps



Product No.	Size	Material	Model No.
32806000		TA	JGMV
32806005	5mm	TA	JGMV
32806010	10mm	TA	JGMV
32806015	15mm	TA	JGMV



NeoGen AR Nail, left

*4.5mm locking screw for distal locking of 9.5mm and 10mm nails

*5.0mm locking screw for distal locking of 11mm and 12mm nails



Product No.	Size	Material	Model No.
32820232	9.5x320mm	TA	JGDVI
32820234	9.5x340mm	TA	JGDVI
32820236	9.5x360mm	TA	JGDVI
32820238	9.5x380mm	TA	JGDVI
32820240	9.5x400mm	TA	JGDVI
32820242	9.5x420mm	TA	JGDVI
32820244	9.5x440mm	TA	JGDVI
32821232	10x320mm	TA	JGDVI
32821234	10x340mm	TA	JGDVI
32821236	10x360mm	TA	JGDVI
32821238	10x380mm	TA	JGDVI
32821240	10x400mm	TA	JGDVI
32821242	10x420mm	TA	JGDVI
32821244	10x440mm	TA	JGDVI
32822232	11x320mm	TA	JGDVI
32822234	11x340mm	TA	JGDVI
32822236	11x360mm	TA	JGDVI
32822238	11x380mm	TA	JGDVI
32822240	11x400mm	TA	JGDVI
32822242	11x420mm	TA	JGDVI
32822244	11x440mm	TA	JGDVI
32823232	12x320mm	TA	JGDVI
32823234	12x340mm	TA	JGDVI
32823236	12x360mm	TA	JGDVI
32823238	12x380mm	TA	JGDVI
32823240	12x400mm	TA	JGDVI
32823242	12x420mm	TA	JGDVI
32823244	12x440mm	TA	JGDVI

NeoGen AR Nail, right

*4.5mm locking screw for distal locking of 9.5mm and 10mm nails

*5.0mm locking screw for distal locking of 11mm and 12mm nails



Product No.	Size	Material	Model No.
32820132	9.5x320mm	TA	JGDVI
32820134	9.5x340mm	TA	JGDVI
32820136	9.5x360mm	TA	JGDVI
32820138	9.5x380mm	TA	JGDVI
32820140	9.5x400mm	TA	JGDVI
32820142	9.5x420mm	TA	JGDVI
32820144	9.5x440mm	TA	JGDVI
32821132	10x320mm	TA	JGDVI
32821134	10x340mm	TA	JGDVI
32821136	10x360mm	TA	JGDVI
32821138	10x380mm	TA	JGDVI
32821140	10x400mm	TA	JGDVI
32821142	10x420mm	TA	JGDVI
32821144	10x440mm	TA	JGDVI
32822132	11x320mm	TA	JGDVI
32822134	11x340mm	TA	JGDVI
32822136	11x360mm	TA	JGDVI
32822138	11x380mm	TA	JGDVI
32822140	11x400mm	TA	JGDVI
32822142	11x420mm	TA	JGDVI
32822144	11x440mm	TA	JGDVI
32823132	12x320mm	TA	JGDVI
32823134	12x340mm	TA	JGDVI
32823136	12x360mm	TA	JGDVI
32823138	12x380mm	TA	JGDVI
32823140	12x400mm	TA	JGDVI
32823142	12x420mm	TA	JGDVI
32823144	12x440mm	TA	JGDVI

NeoGen Locking Screws



Product No.	Size	Type	Material	Model No.
33111025	4.5x26mm	Blue	TA	JSDVII
33111030	4.5x30mm	Blue	TA	JSDVII
33111035	4.5x35mm	Blue	TA	JSDVII
33111040	4.5x40mm	Blue	TA	JSDVII
33111045	4.5x45mm	Blue	TA	JSDVII
33111050	4.5x50mm	Blue	TA	JSDVII
33111055	4.5x55mm	Blue	TA	JSDVII
33111060	4.5x60mm	Blue	TA	JSDVII
33111065	4.5x65mm	Blue	TA	JSDVII
33111070	4.5x70mm	Blue	TA	JSDVII
33111075	4.5x75mm	Blue	TA	JSDVII
33111080	4.5x80mm	Blue	TA	JSDVII
33111085	4.5x85mm	Blue	TA	JSDVII
33111090	4.5x90mm	Blue	TA	JSDVII
33112025	5.0x26mm	Dark Golden	TA	JSDVII
33112030	5.0x30mm	Dark Golden	TA	JSDVII
33112035	5.0x35mm	Dark Golden	TA	JSDVII
33112040	5.0x40mm	Dark Golden	TA	JSDVII
33112045	5.0x45mm	Dark Golden	TA	JSDVII
33112050	5.0x50mm	Dark Golden	TA	JSDVII
33112055	5.0x55mm	Dark Golden	TA	JSDVII
33112060	5.0x60mm	Dark Golden	TA	JSDVII
33112065	5.0x65mm	Dark Golden	TA	JSDVII
33112070	5.0x70mm	Dark Golden	TA	JSDVII
33112075	5.0x75mm	Dark Golden	TA	JSDVII
33112080	5.0x80mm	Dark Golden	TA	JSDVII
33112085	5.0x85mm	Dark Golden	TA	JSDVII
33112090	5.0x90mm	Dark Golden	TA	JSDVII
33112091	5.0x95mm	Dark Golden	TA	JSDVII
33112092	5.0x100mm	Dark Golden	TA	JSDVII
33112093	5.0x105mm	Dark Golden	TA	JSDVII
33112094	5.0x110mm	Dark Golden	TA	JSDVII

NeoGen Nail Instruments Set

Code	Product Description	Qty
899460	Neogen Nail Instruments Set	
898357	Neogen Nail Basic Instruments Set (Empty)-PPSU	1
898358	NeoGen Nail Special Instruments Set (Empty)-PPSU	1
898196	NeoGen Nail Special Instruments Set Empty Tray	1
899461	Awl	1
899464	Tissue Protector	1
899467	L-Hex Wrench, SW3 for Stopper Φ 7mm	1
899469	Reducer	1
899470	Ball Tip Guide Wire	1
899471	Guide Wire Holder	1
050013	Hex Reamer Shaft-Dual Direction	1
899472	Hex Reamer Shaft-Mono Direction	1
050085	Reamer, Φ 8.5mm	1
050090	Reamer, Φ 9mm	1
050095	Reamer, Φ 9.5mm	1
050100	Reamer, Φ 10mm	1
050105	Reamer, Φ 10.5mm	1
050110	Reamer, Φ 11mm	1
050115	Reamer, Φ 11.5mm	1
050120	Reamer, Φ 12mm	1
050125	Reamer, Φ 12.5mm	1
050130	Reamer, Φ 13mm	1
050135	Reamer, Φ 13.5mm	1
899468	T-Handle with Quick Coupling	1
899497	Guide Bolt Wrench Shaft	1
899498	Extractor	1
899499	Insertion Handle	1
899500	Guide Bolt	2
899502	Impactor	1
899489	Guide Wire Sleeve 2.5	1
899490	Guide Wire, Φ 2.5mm	3
899491	Guide Wire with Threaded Tip , Φ 2.5mm	3

Code	Product Description	Qty
899492	Direct Measuring Device for Guide Wires	1
899484	Screw Depth Gauge	1
899485	Tap, Φ 4.5mm	1
899486	Tap, Φ 5.0mm	1
899496	Tap, Φ 6.4mm	1
899493	Drill Sleeve 6.4	2
899494	Drill Bit, Φ 6.4mm	1
899495	Stopper, Φ 6.4mm	1
899487	Screwdriver for Locking Screw	1
899488	Screwdriver for Locking Screw, Long	1
899503	Proximal Bolt	2
899504	Distal Bolt	3
899505	Bolt Wrench, SW5.0	1
899506	Trochar Sleeve (Position Rod)	1
899507	Trochar (Position Rod)	1
899508	Drill Sleeve 5.2 (Position Rod)	1
899509	Drill Bit, Φ 5.2mm (Position Rod)	1
899510	Position Rod Drill (Position Rod)	1
899511	Trocar Sleeve for Locking Screw	2
899512	Trocar for Locking Screw	1
899513	Drill Sleeve 4.0	1
899514	Drill Sleeve 4.3	1
899515	Drill Bit, Φ 4.0mm	2
899516	Stopper, Φ 4.0mm	1
899517	Drill Bit, Φ 4.3mm	2
899518	Stopper, Φ 4.3mm	1
899519	Replacement Rod	1
899462	Entry Inner Trochar (Femur)	1
899463	Entry Drill Sleeve (Femur)	1
899465	Entry Reamer (Femur)	1
899466	Stopper, Φ 7mm	2
899520	Proximal Aiming Bar (Femur)	1

Code	Product Description	Qty
899521	Distal Aiming Bar (Femur)	1
899522	Targeter (Femur)	1
899523	Position Rod	1
899524	E Block 10/9 (Femur)	1
899525	E Block 12/11 (Femur)	1
898127	Entry Inner Trochar (Knee)	1
898128	Entry Drill Sleeve (Knee)	1
898122	Entry Reamer (Knee)	1
899526	Proximal Aiming Bar (Knee),Left	1
899527	Proximal Aiming Bar (Knee),Right	1
899531	Proximal Aiming Device (Knee)	1
899528	Distal Aiming Bar (Knee)	1
899529	Targeter (Knee)	1
899530	Position Rod (Knee)	1
899532	E Block 9/8(Knee)	1
899533	E Block 11.5/10 (Knee)	1
899535	Aiming Bar(GAMMA)	1
266141	Drill Bit(GAMMA)	1
899536	Outer Drill Sleeve(GAMMA)	1
899537	Drill Sleeve(GAMMA)	1
899538	Guide Bolt(GAMMA)	2
266110	Reamer(GAMMA)	1
266150	Screwdriver(GAMMA)	1
266160	Coupling Screw(GAMMA)	1
266170	Tap(GAMMA)	1
899534	T-handle with quick coupling(GAMMA)	1
898195	NeoGen Nail Special Instruments Set Gamma Tray	1

Please contact your sales representative for final product list.



NeoGen Nail Instruments Set



Neogen Nail Basic Instruments Set

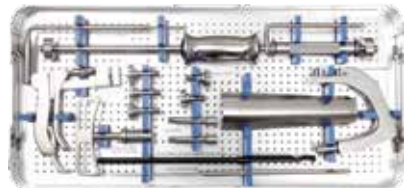
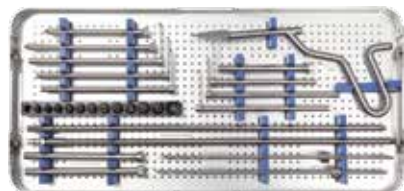
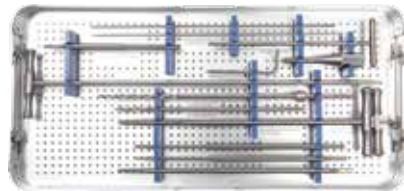

Neogen Nail Special Instruments Set

898196

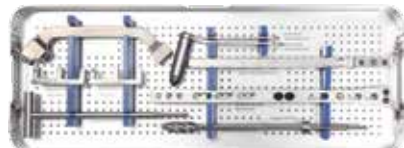
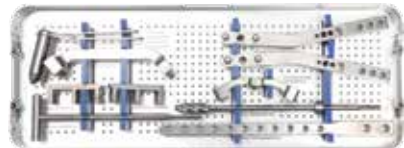
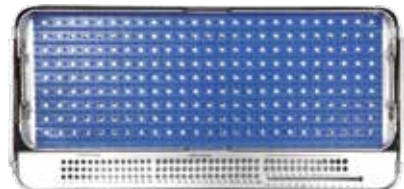



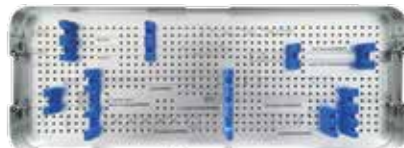



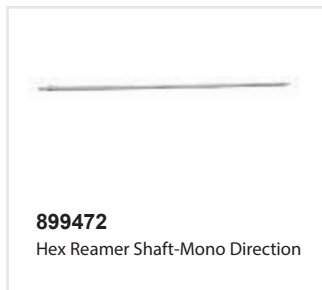
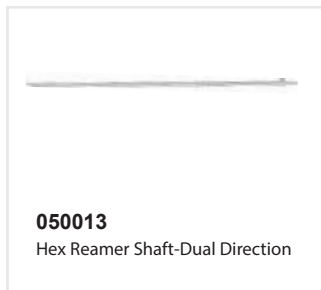
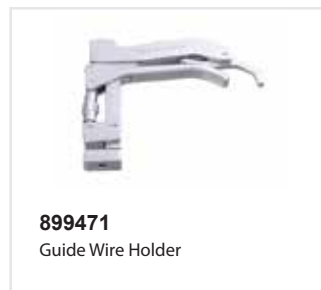
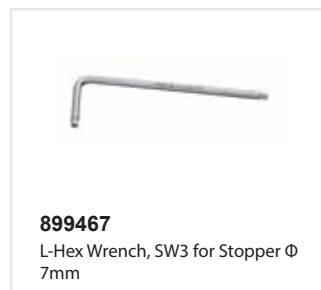







898195



Instruments



 <p>050120 Reamer, Ø 12mm</p>	 <p>050125 Reamer, Ø 12.5mm</p>	 <p>050130 Reamer, Ø 13mm</p>
 <p>050135 Reamer, Ø 13.5mm</p>	 <p>899468 T-handle with Quick Coupling</p>	 <p>899497 Guide Bolt Wrench Shaft</p>
 <p>899498 Extractor</p>	 <p>899499 Insertion Handle</p>	 <p>899500 Guide Bolt</p>
 <p>899502 Impactor</p>	 <p>899489 Guide Wire Sleeve 2.5</p>	 <p>899490 Guide Wire, Ø 2.5mm</p>
 <p>899491 Guide Wire with Threaded Tip, Ø 2.5mm</p>	 <p>899492 Direct Measuring Device for Guide Wires</p>	 <p>899484 Screw Depth Gauge</p>

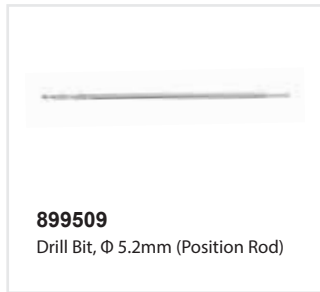
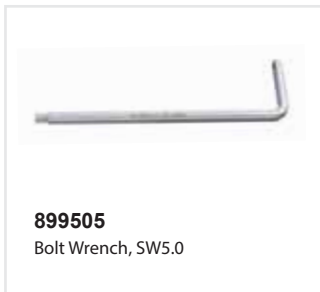
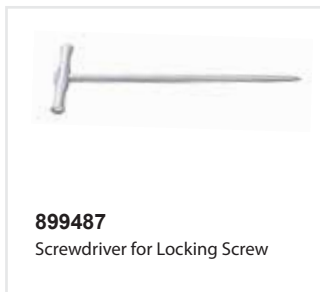
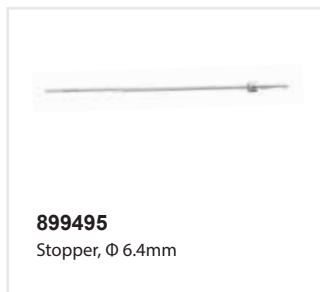
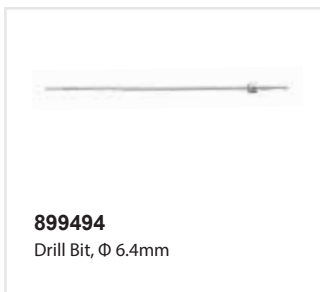
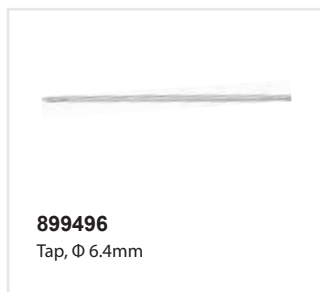
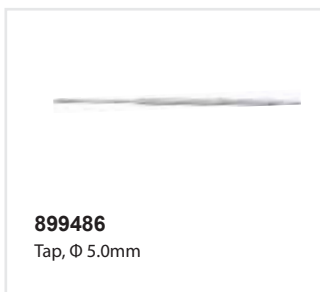
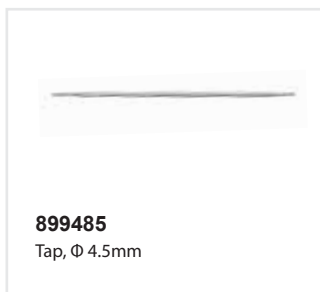

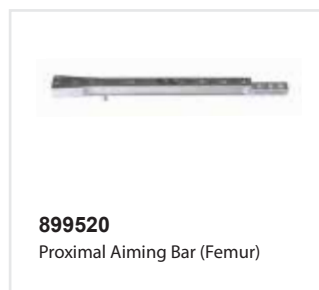
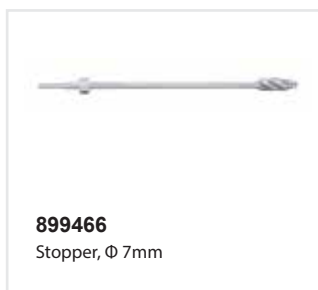
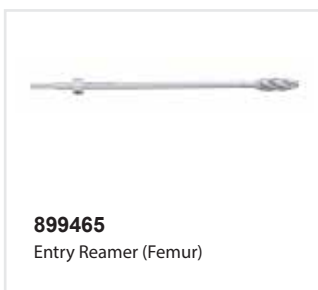
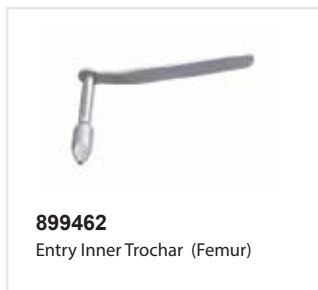
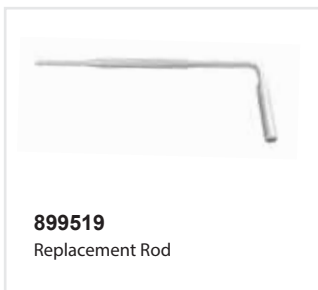
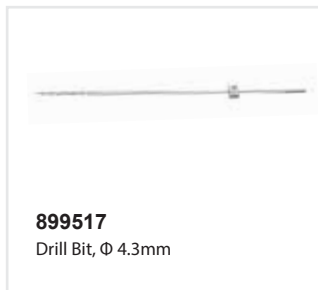
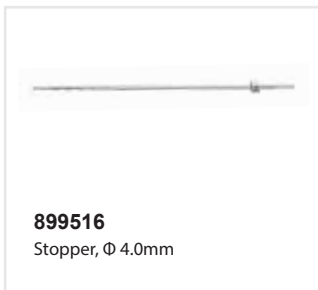
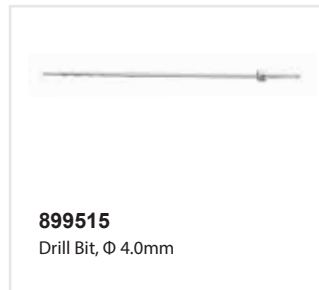
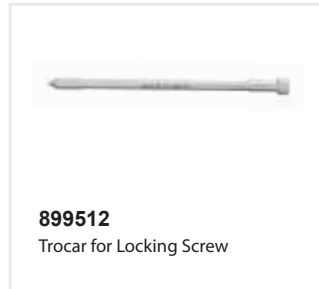
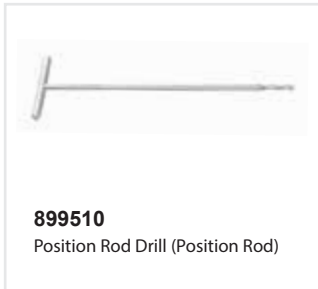

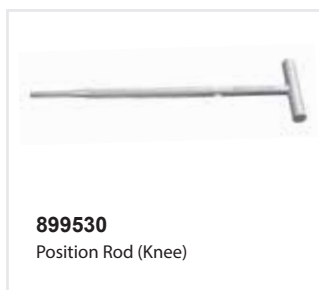
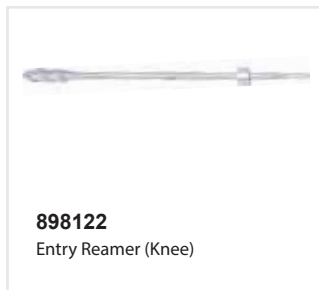

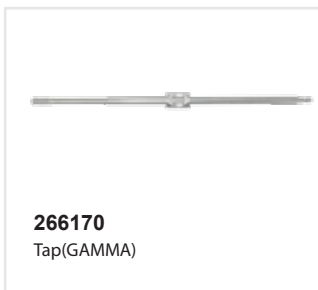
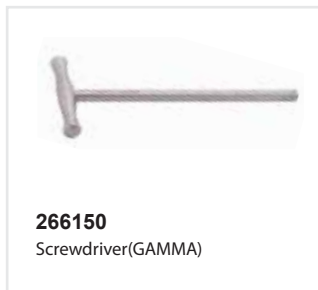
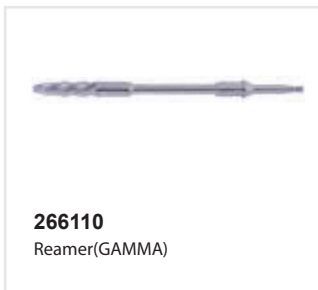
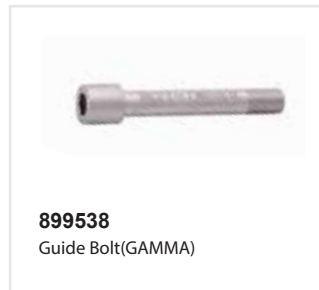
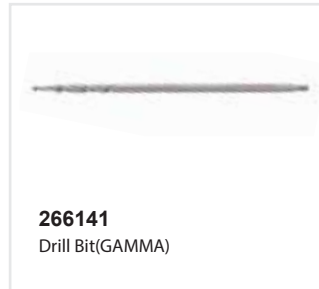
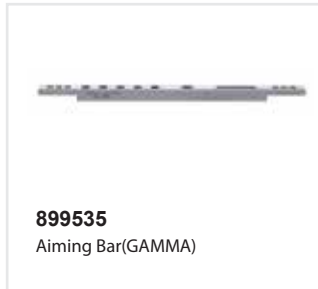

NeoGen AR Nail Instruments Set

Code	Product Description	Qty
269900	NeoGen AR Nail Instruments Set	1
898367	NeoGen AR Nail Instruments Set (Empty)-PPSU	1
269920	NeoGen AR Nail Instruments Set Case	1
269930	NeoGen AR Nail Instruments Set Tray 1	1
269940	NeoGen AR Nail Instruments Set Tray 2	1
269950	NeoGen AR Nail Instruments Set Tray 3	1
269960	NeoGen AR Nail Instruments Set Tray 4	1
267120	Insertion Connecting Rod	1
267130	Insertion Connector	1
267140	Bolt for Aiming Arm 130°	1
267150	Protection Sleeve for AR Blade	1
267160	Trocar Sleeve 3.2	1
267170	Trocar, Φ 3.2mm	1
267180	Direct Measuring Device for Guide Wire Φ 3.2mm	1
267190	Outer Sleeve for Distal Locking Screw	2
267200	Drill Sleeve 4.0	2
267210	Trocar, Φ 4.0mm	1
267220	Depth Gauge for Distal Locking Screw	1
267230	Screwdriver for Distal Locking Screw	1
267240	Screwdriver, Hexagonal with Spherical Head	1
267250	Guide Wire with Hook for Cap	1
267260	Screwdriver for Cap, cannulated	1
267270	Extended Rod, Cannulated	1
267290	Cleaning Stylet	1
267300	Extraction Screw for Nail	1
267310	Slotted Hammer	1
267320	Extraction Screw for AR Blade	1
267330	Screwdriver, Hexagonal	1
267340	Drill Bit, Φ 4.0mm	2
267350	Screwdriver for AR Blade	1
267360	Reamer for AR Blade	1
267370	Cannulated Drill Bit for AR Blade	1
267390	Tip Threaded Guide Wire, Φ 3.2 mm	2
267400	Stopper, Φ 10mm	1
267410	Combination Wrench	1
267450	Hammer	1
267460	Buttress Nut	1

Code	Product Description	Qty
267470	Tissue Protector	1
267480	Key for AR Blade	1
267510	Slotted Hammer Guide for AR Blade	1
267520	Radiographic Ruler	1
267530	Cannulated Awl	1
267540	Connecting Rod	1
267560	Guide Wire,Φ 3.2 mm	2
269100	Proximal Aiming Bar for Long Nail	1
269110	Distal Aiming Bar for Long Nail	1
269120	Targeter	1
269140	Position Rod Drill,Φ 5.2mm	1
269150	Drill Bit, Φ 5.2mm	1
269160	Trochar Sleeve 8.1	1
269170	Drill Sleeve 5.2	1
269180	Trochar 8.1	1
269190	Ball Tip Guide Wire 2.5	1
269200	Reducer	1
269210	Wrench, SW5 for Bolt	1
269240	Guide Wire Holder	1
269250	Proximal Bolt	1
269260	Bolt for Targeter	1
269270	Distal Bolt	1
269280	Reamer Shaft	2
269290	Reamer, Φ 9mm	1
269300	Reamer, Φ 10mm	1
269310	Reamer, Φ 11mm	1
269320	Reamer, Φ 12mm	1
269330	Reamer, Φ 13mm	1
269340	E Block	1
269350	Position Rod	1
269360	Drill Bit, Φ 4.3mm	2
269370	Drill Sleeve 4.3	2
269380	Wrench for Stopper	1
269390	Stopper, Φ 4.3mm	1
269400	Insertion Handle	1
269410	Aiming Arm 130° for Static Locking	1
269420	Connecting Screw	1

Please contact your sales representative for final product list.



Code	Product Description	Qty
269430	T- Handle with Quick Coupling	1
269440	Aiming Arm 130° for Dynamic Locking	1
269450	Entry Reamer,Φ 17.0mm	1
269460	Protection Sleeve	1
269470	Guide Sleeve 17	1
269480	Replacement Rod	1

NeoGen AR Nail Instruments Set

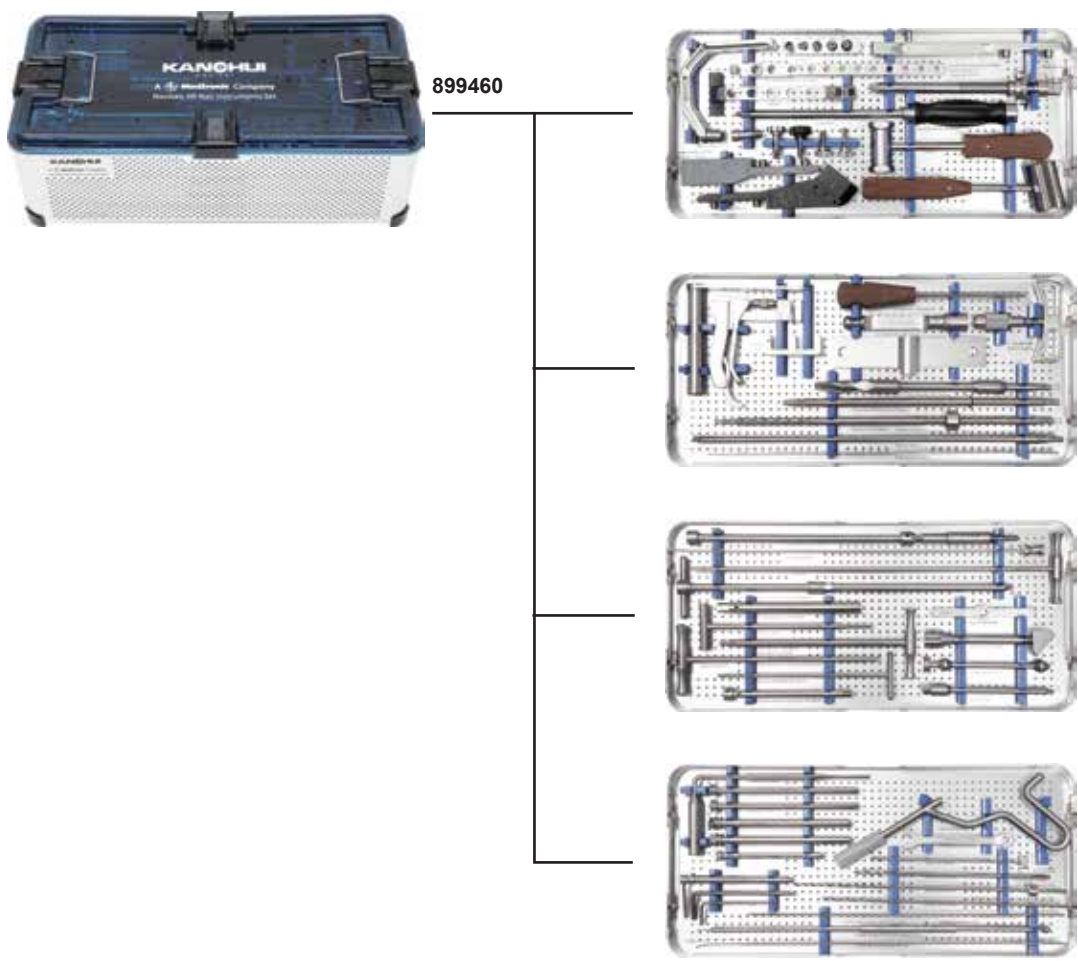

Instruments



267120
Insertion Connecting Rod



267130
Insertion Connector



267140
Bolt for Aiming Arm 130°



267150
Protection Sleeve for AR Blade



267160
Trocar Sleeve 3.2



267170
Trocar, Ø 3.2mm



267180
Direct Measuring Device for Guide Wire Ø 3.2mm



267190
Outer Sleeve for Distal Locking Screw



267200
Drill Sleeve 4.0



267210
Trocar, Ø 4.0mm



267220
Depth Gauge for Distal Locking Screw



267230
Screwdriver for Distal Locking Screw



267240
Screwdriver, Hexagonal with Spherical Head



267250
Guide Wire with Hook for Cap



267260
Screwdriver for Cap, cannulated

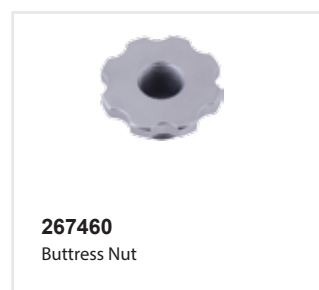
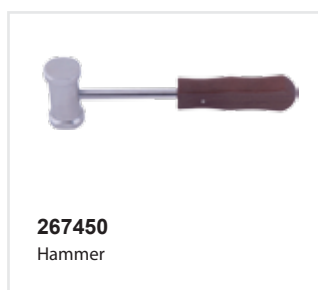
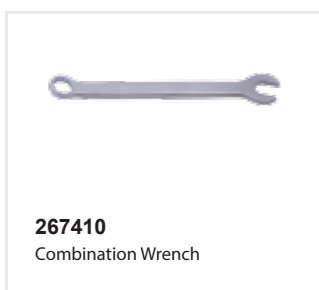
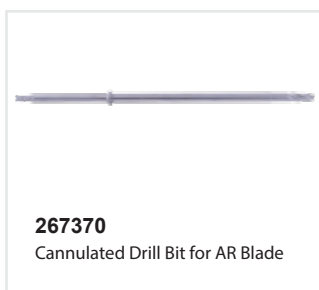
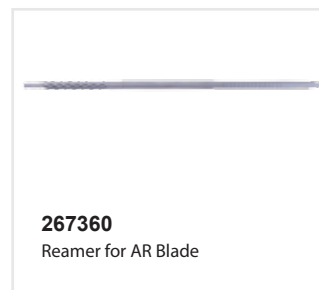
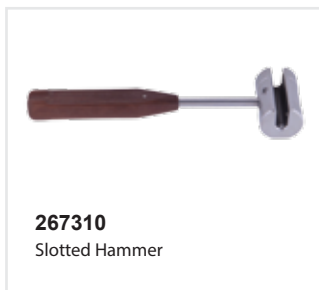

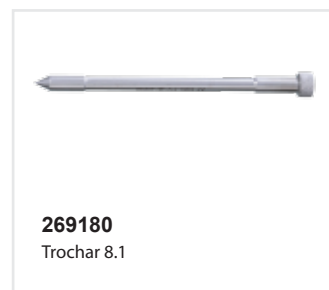
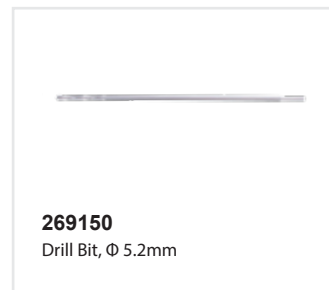
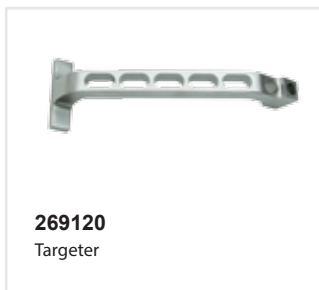
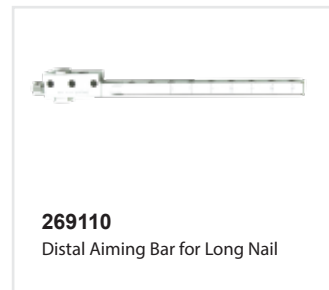
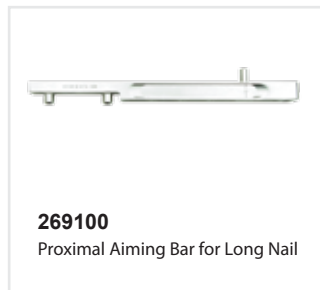
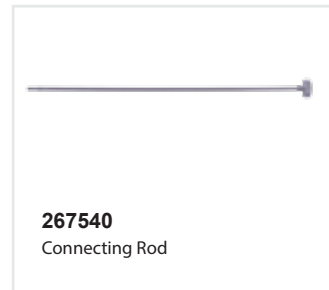
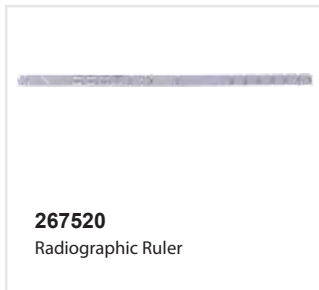
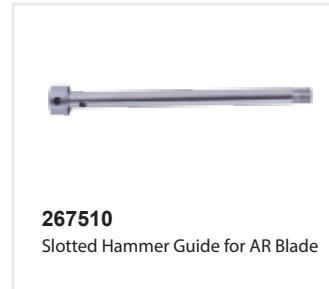
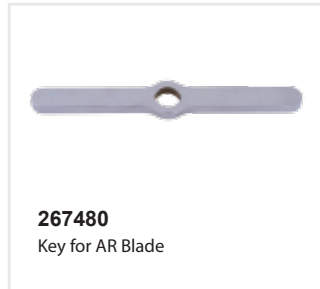

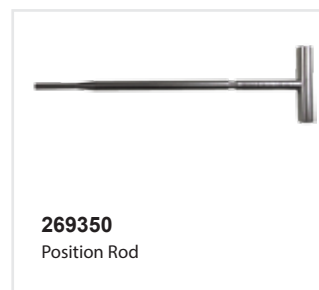
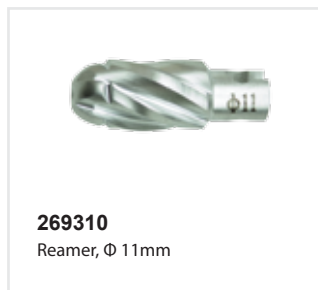
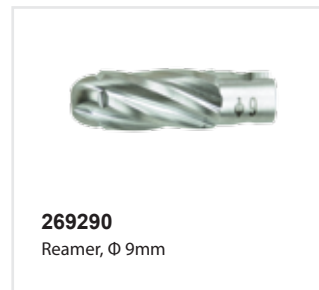
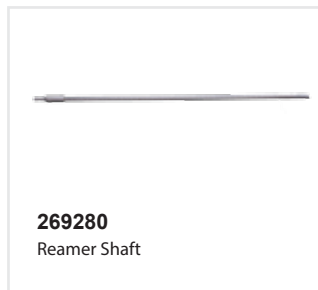
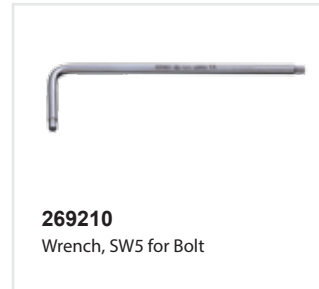
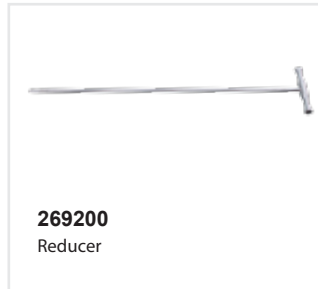

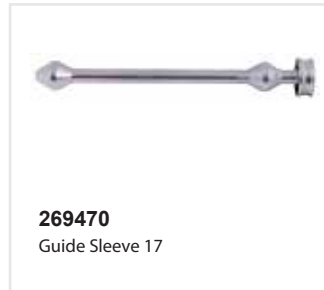
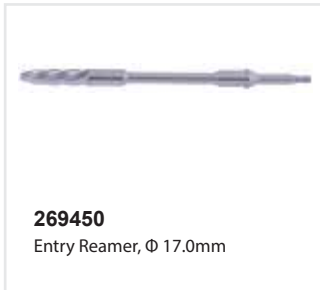
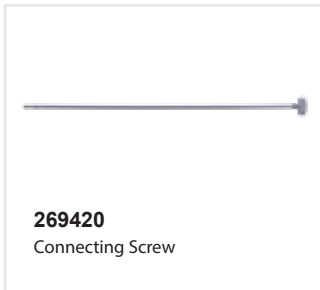
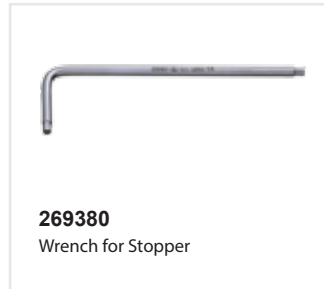
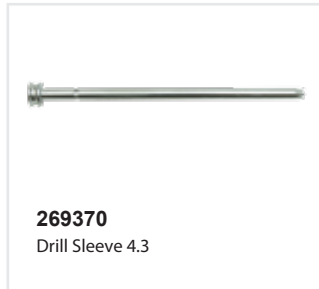
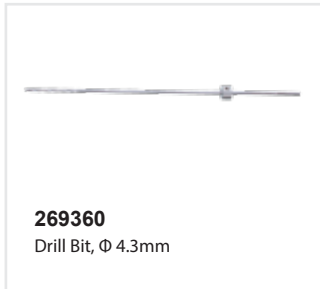

NeoGen Gamma Nails Instruments Set

Code	Product Description	Qty
830000	Neogen Gamma Nail Instrumenst Set	
898360	Neogen Gamma Nail Instrumenst Set (Empty)-PPSU	1
266220	Conical Reamer Sleeve	1
266210	Multihole Trocar	1
266190	Awl, curved	1
266200	Reamer	1
251110	Tip Threaded Guide Wire	3
030070	T-Handle with Quick Coupling	1
251162	Ball Tip Guide Rod	1
251170	Gripper	1
251150	Reducer	1
251190	Insertion Handle	1
251200	Proximal Guide Bolt	2
251220	Guide Bolt Wrench	1
251230	Quick Bolt	1
251460	Impactor	1
251240	Hammer	1
251250	Tissue Protector	1
251260	Outer Drill Sleeve	2
251270	Inner Drill Sleeve	2
251285	Small Drill Sleeve	2
251290	Drill Bit, Φ 4.0mm	2
251300	Tap, Φ 5.0mm	1
251410	T-handle	1
251510	Screw Depth Gauge	1
251500	Screw Driver for Locking Screws	2
251520	Connecting Rod	2
251370	Extrator	1
251400	Replacement Rod	1
251480	Trocar	1
251445	Thread Pin Sleeve	1
10737300	Threaded Pin, Φ 2.0mm	2



Code	Product Description	Qty
251470	Allen Key	1
266100	Proximal Aiming Bar	1
266120	Guide Bolt	2
266130	Outer Drill Sleeve	1
266141	Drill Bit	1
266150	Locking Screwdriver for Lag Screw	1
266160	Coupling Screw	1

Please contact your sales representative for final product list.



NeoGen Gamma Nails Instruments Set



830000

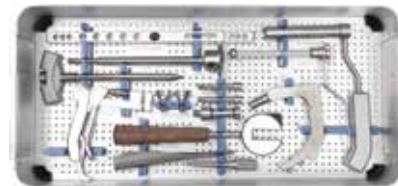
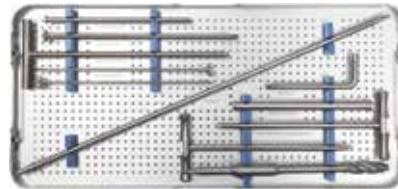
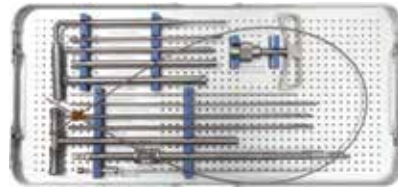
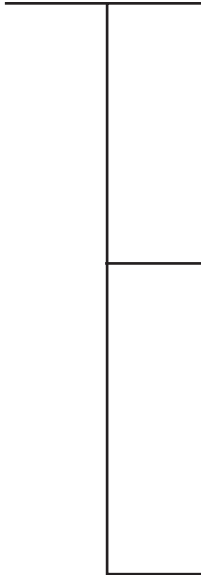

Instruments

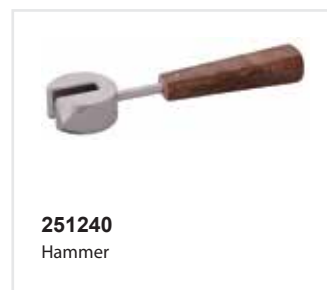
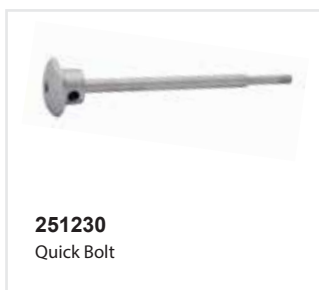
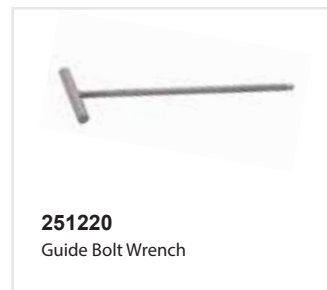
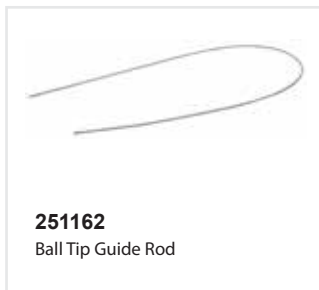
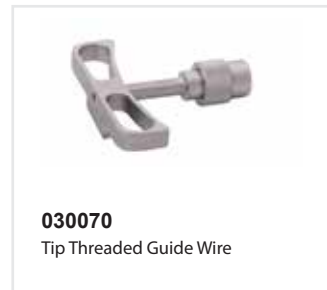

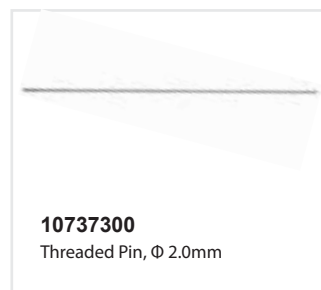
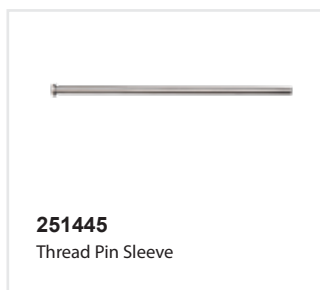
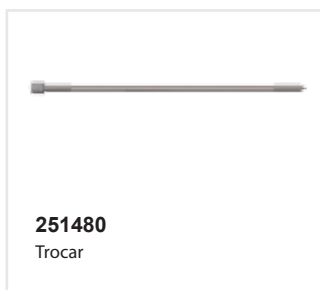
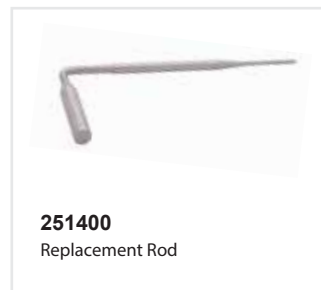
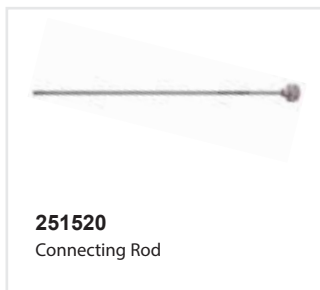
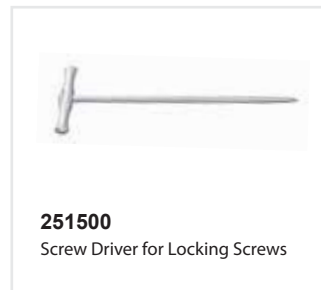
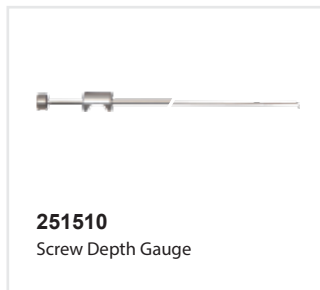
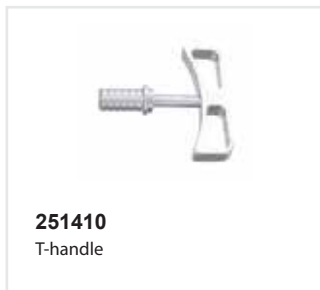
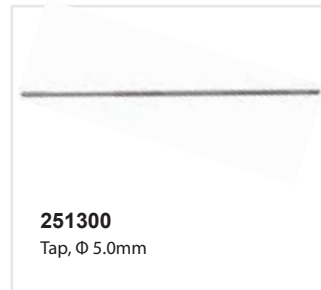
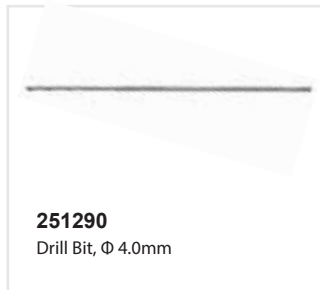



251470
Allen Key



266100
Proximal Aiming Bar



266120
Guide Bolt



266130
Outer Drill Sleeve



266141
Drill Bit



266150
Locking Screwdriver for Lag Screw



266160
Coupling Screw

External Fixator System

- External Fixator-Large
- External Fixator-Medium
- External Fixator-Small
- External Fixator-Mini
- Optimus



External Fixator Large



Schanz Screws, self-drilling



Product No.	Size	Material	Model No.
10742125	Φ5×125	SS	GZLW01SJB
10742150	Φ5×150	SS	GZLW01SJB
10742175	Φ5×175	SS	GZLW01SJB
10742200	Φ5×200	SS	GZLW01SJB

Schanz Screws



Product No.	Size	Material	Model No.
10744125	Φ5×125	SS	GZLW08SJB
10744150	Φ5×150	SS	GZLW08SJB
10744175	Φ5×175	SS	GZLW08SJB
10744200	Φ5×200	SS	GZLW08SJB

Combination Clamp, Clip-on, self-holding (large)



Product No.	Size	Material	Model No.
521110	Φ11	TA	WGD-ZHX-II-05

Clamp, Clip-on, self-holding (large)



Product No.	Size	Material	Model No.
521120	Φ11	TA	WGD-ZHX-II-03

Rod-to-Rod Clamp(large)



Product No.	Size	Material	Model No.
521130	Φ11	TA	WGD-ZHX-II-06

Connecting Rods



Product No.	Size	Material	Model No.
521140	Φ11x100	Carbon Fiber	WGD-ZHX-II-01
521150	Φ11x125	Carbon Fiber	WGD-ZHX-II-01
521160	Φ11x150	Carbon Fiber	WGD-ZHX-II-01
521170	Φ11x200	Carbon Fiber	WGD-ZHX-II-01
521180	Φ11x250	Carbon Fiber	WGD-ZHX-II-01
521190	Φ11x300	Carbon Fiber	WGD-ZHX-II-01
521200	Φ11x350	Carbon Fiber	WGD-ZHX-II-01
521210	Φ11x400	Carbon Fiber	WGD-ZHX-II-01

Protective Caps



Product No.	Size	Material	Model No.
521230	Φ11x27	Silicon	WGD-ZHX-II-08
521240	Φ5x27	Silicon	WGD-ZHX-II-08

External Fixator Medium



Schanz Screws, self-drilling



Product No.	Size	Material	Model No.
10741100	Φ4x100	SS	GZLW01SJB
10741125	Φ4x125	SS	GZLW01SJB
10741150	Φ4x150	SS	GZLW01SJB

Schanz Screws



Product No.	Size	Material	Model No.
10743125	Φ4×125	SS	GZLW08SJB
10743150	Φ4×150	SS	GZLW08SJB

Combination Clamp, Clip-on, self-holding (medium)



Product No.	Size	Material	Model No.
521330	Φ8	TA	WGD-ZHX-II-05

Clamp, Clip-on, self-holding (medium)



Product No.	Size	Material	Model No.
521320	Φ8	TA	WGD-ZHX-II-03

Rod-to-Rod Clamp (medium)



Product No.	Size	Material	Model No.
521310	Φ8	TA	WGD-ZHX-II-06

Connecting Rods



Product No.	Size	Material	Model No.
521340	Φ8x120	Carbon Fiber	WGD-ZHX-II-01
521350	Φ8x160	Carbon Fiber	WGD-ZHX-II-01
521360	Φ8x200	Carbon Fiber	WGD-ZHX-II-01
521370	Φ8x220	Carbon Fiber	WGD-ZHX-II-01
521380	Φ8x240	Carbon Fiber	WGD-ZHX-II-01
521390	Φ8x280	Carbon Fiber	WGD-ZHX-II-01
521400	Φ8x320	Carbon Fiber	WGD-ZHX-II-01
521410	Φ8x360	Carbon Fiber	WGD-ZHX-II-01
521420	Φ8x400	Carbon Fiber	WGD-ZHX-II-01

Protective Caps



Product No.	Size	Material	Model No.
521430	Φ8x27	Silicon	WGD-ZHX-II-08
521440	Φ4x27	Silicon	WGD-ZHX-II-08

External Fixator Small

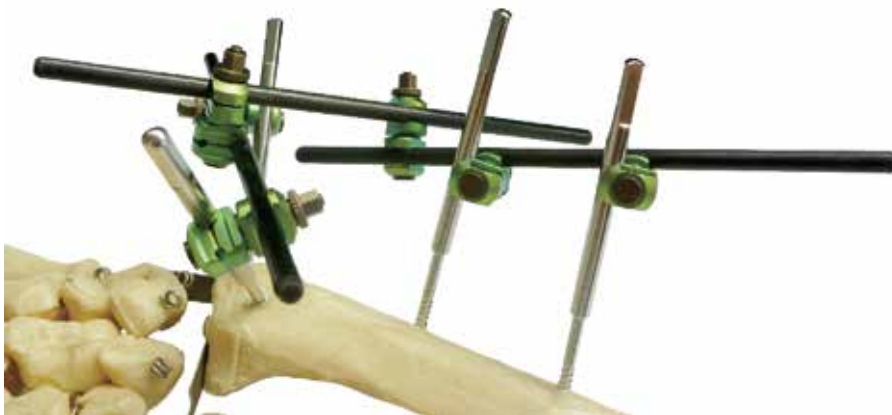



Schanz Screws, self-drilling



Product No.	Size	Material	Model No.
10740065	Φ3x65	SS	GZLW01SJB
10740080	Φ3x80	SS	GZLW01SJB
10739080	Φ2.5x80	SS	GZLW01SJB

K-wire



Product No.	Size	Material	Model No.
10735150	Φ1.8x150	SS	GZZh01YA
10705150	Φ2.0x150	SS	GZZh01YA
10727150	Φ2.5x150	SS	GZLW02YA

Combination Clamp, Clip-on, self-holding (small)



Product No.	Size	Material	Model No.
521530	Φ4	TA	WGD-ZHX-II-05

Clamp, Clip-on, self-holding (small)



Product No.	Size	Material	Model No.
521510	Φ4	TA	WGD-ZHX-II-03

Rod-to-Rod Clamp(small)



Product No.	Size	Material	Model No.
521520	Φ4	TA	WGD-ZHX-II-06

Connecting Rods



Product No.	Size	Material	Model No.
521540	Φ4x60	Carbon Fiber	WGD-ZHX-II-01
521550	Φ4x80	Carbon Fiber	WGD-ZHX-II-01
521560	Φ4x100	Carbon Fiber	WGD-ZHX-II-01
521570	Φ4x120	Carbon Fiber	WGD-ZHX-II-01
521580	Φ4x140	Carbon Fiber	WGD-ZHX-II-01
521590	Φ4x160	Carbon Fiber	WGD-ZHX-II-01
521600	Φ4x180	Carbon Fiber	WGD-ZHX-II-01
521610	Φ4x200	Carbon Fiber	WGD-ZHX-II-01



Protective Caps



Product No.	Size	Material	Model No.
521620	Φ2.5x27	Silicon	WGD-ZHX-II-08
521440	Φ4x27	Silicon	WGD-ZHX-II-08

External Fixator Mini



Clamp Holder



Product No.	Size	Material	Model No.
521710	Φ1.25	SS	WGD-ZHX-II-03
521720	Φ1.6	SS	WGD-ZHX-II-03

Connecting Clamp (mini)



Product No.	Size	Material	Model No.
521730	Φ3	SS	WGD-ZHX-II-05

Angular Connecting Rods



Product No.	Material	Model No.
521740	SS	WGD-ZHX-II

Connecting Rods



Product No.	Size	Material	Model No.
521750	Φ3x25	Carbon Fiber	WGD-ZHX-II-01
521760	Φ3x45	Carbon Fiber	WGD-ZHX-II-01
521770	Φ3x60	Carbon Fiber	WGD-ZHX-II-01
521780	Φ3x75	Carbon Fiber	WGD-ZHX-II-01

K-wire, threaded

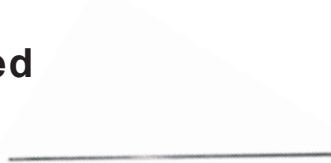

Product No.	Size	Material	Model No.
10736100	Φ1.2×100	SS	GZLW02YA
10726100	Φ1.6×100	SS	GZLW02YA

Ring Fixator for Trauma

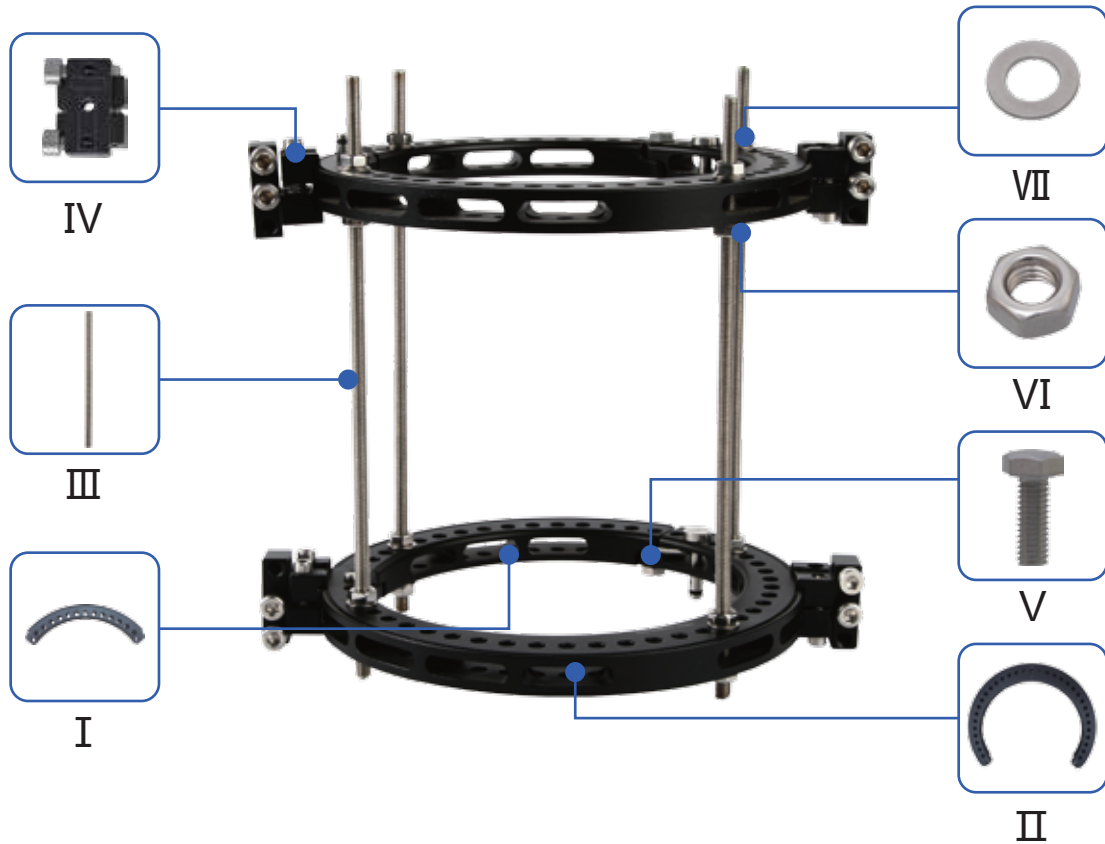

I - 1/4 Ring

Product No.	Size	Material	Model No.
541110	Φ120	Magal	WGD-HX-I-04
541120	Φ150	Magal	WGD-HX-I-04
541130	Φ175	Magal	WGD-HX-I-04
541140	Φ190	Magal	WGD-HX-I-04
541150	Φ220	Magal	WGD-HX-I-04

II - 3/4 Ring

Product No.	Size	Material	Model No.
541160	Φ120	Magal	WGD-HX-I-02
541170	Φ150	Magal	WGD-HX-I-02
541180	Φ175	Magal	WGD-HX-I-02
541190	Φ190	Magal	WGD-HX-I-02
541200	Φ220	Magal	WGD-HX-I-02

III - Threaded Bar

Product No.	Size	Material	Model No.
541210	Φ6x200	SS	WGD-HX-I-05

IV - Three-hole Wire Clamp

Product No.	Size	Material	Model No.
541220	40	Magal	WGD-HX-I-13

V - Ring Locking Screw

Product No.	Size	Material	Model No.
541240	Φ6	SS	WGD-HX-I-11



VI- Nut

Product No.	Size	Material	Model No.
541250	Φ5	SS	WGD-HX-I-09

VII- Wash

Product No.	Size	Material	Model No.
541260	Φ7	SS	WGD-HX-I-10

Kirschner Wires



Product No.	Size	Material	Model No.
10754350	Φ2×350	SS	GZB01YA

Full Ring Fixator

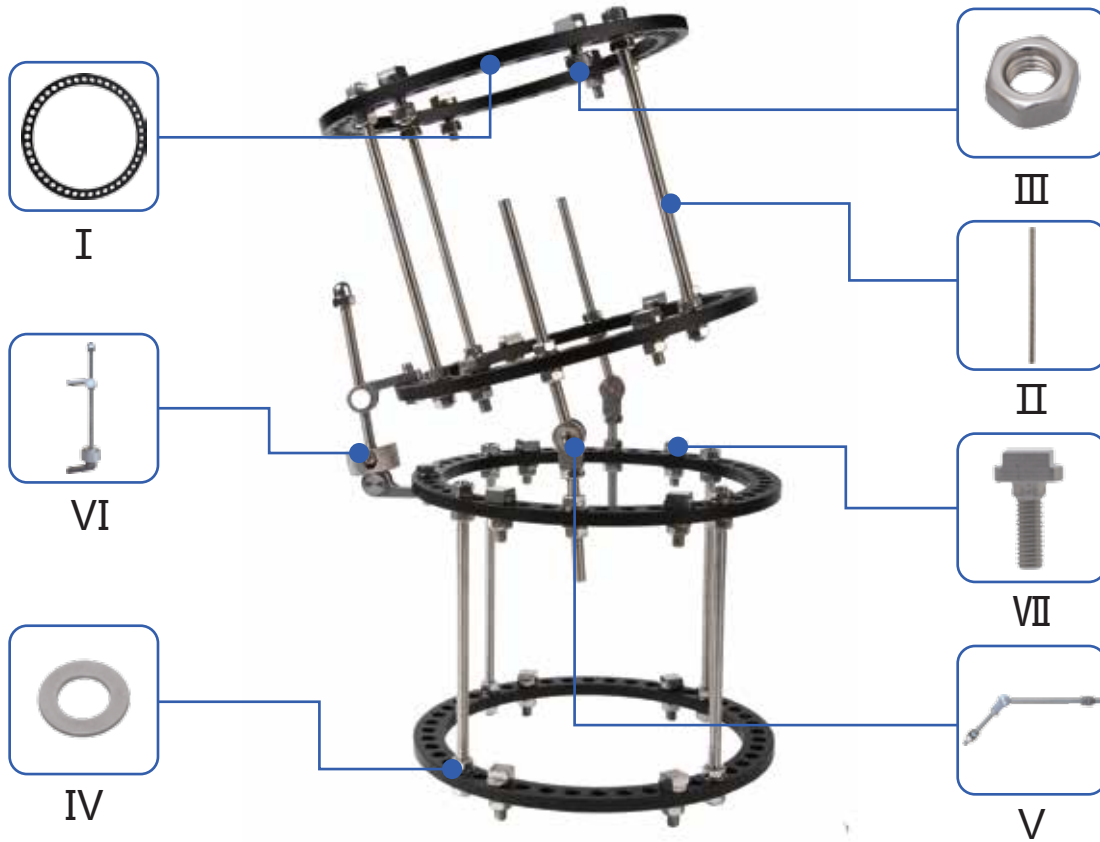

I - Full Ring

Product No.	Size	Material	Model No.
542110	Φ100	Magal	WGD-HX-I-01
542120	Φ120	Magal	WGD-HX-I-01
542130	Φ140	Magal	WGD-HX-I-01
542140	Φ160	Magal	WGD-HX-I-01
542150	Φ180	Magal	WGD-HX-I-01
542160	Φ200	Magal	WGD-HX-I-01
542170	Φ220	Magal	WGD-HX-I-01
542180	Φ240	Magal	WGD-HX-I-01



II - Threaded Bar

Product No.	Size	Material	Model No.
542190	Φ6x110	SS	WGD-HX-I-05

III - Nut

Product No.	Size	Material	Model No.
541250	Φ5	SS	WGD-HX-I-09

IV - Wash

Product No.	Size	Material	Model No.
541260	Φ7	SS	WGD-HX-I-10

V - Hinge Assembly

Product No.	Size	Material	Model No.
542200	Φ10	SS	WGD-HX-I-12

VI- Angular Distractor

Product No.	Size	Material	Model No.
542210	Φ10	SS	WGD-HX-I-14

VII- Universal wire Fixation bolt

Product No.	Size	Material	Model No.
541220	Φ10	SS	WGD-HX-I-08

Kirschner Wires



Product No.	Size	Material	Model No.
10754350	Φ2×350	SS	GZB01YA

Micro movement Fixator



Product No.	Specification	Size	Material	Model No.
544110	Long	Φ18x390	Magal	WGD-ZX-I
544120	Standard	Φ18x310	Magal	WGD-ZX-I
544130	Short	Φ18x270	Magal	WGD-ZX-I
544140	Pediatric	Φ12x220	Magal	WGD-ZX-I

Micro movement Fixator with T-clamp



Product No.	Specification	Size	Material	Model No.
545110	Long	Φ18x350	Magal	WGD-ZX-II
545120	Standard	Φ18x270	Magal	WGD-ZX-II
545130	Short	Φ18x230	Magal	WGD-ZX-II

Micro Movement Fixator with GT-clamp



Product No.	Specification	Size	Material	Model No.
546110	Long	Φ18x355	Magal	WGD-ZX-II
546120	Medium	Φ18x275	Magal	WGD-ZX-II
546130	Short	Φ18x235	Magal	WGD-ZX-II



Pre-drilled Cortical Screws



Product No.	Size	Material	Model No.
10752100	Φ6x100	SS	GZLW04BA
10752110	Φ6x110	SS	GZLW04BA
10752120	Φ6x120	SS	GZLW04BA
10752130	Φ6x130	SS	GZLW04BA
10752150	Φ6x150	SS	GZLW04BA
10752170	Φ6x170	SS	GZLW04BA
10752180	Φ6x180	SS	GZLW04BA
10752200	Φ6x200	SS	GZLW04BA
10756080	Φ4.5x80	SS	GZLW05BA
10756100	Φ4.5x100	SS	GZLW05BA
10756120	Φ4.5x120	SS	GZLW05BA

Self-Drilling Cortical Screws



Product No.	Size	Material	Model No.
10755150	Φ6x150	SS	GZLW05BA
10755160	Φ6x160	SS	GZLW05BA
10755210	Φ6x210	SS	GZLW05BA
10755220	Φ6x220	SS	GZLW05BA
10755230	Φ6x230	SS	GZLW05BA
10755250	Φ6x250	SS	GZLW05BA



Wrist Fixator



Product No.	Size	Material	Model No.
547110	Φ12x220	Magal	WGD-ZX-IV

Pre-drilled Cortical Screws



Product No.	Size	Material	Model No.
10751070	Φ4x70	SS	GZLW04BA
10751080	Φ4x70	SS	GZLW04BA

Mini Fixator



Product No.	Specification	Size	Material	Model No.
548110	Long	Φ6x85	Magal	WGD-ZX-V
548120	Standard	Φ6x75	Magal	WGD-ZX-V
548130	Short	Φ6x65	Magal	WGD-ZX-V

Self-drilling Cortical Screws



Product No.	Size	Material	Model No.
10753100	Φ2x100	SS	GZLW02YB

External Fixator (Large) Instruments Set

Code	Product Description	Qty
522900	External Fixator (Large) Instruments Set	
898364	External Fixator (Large) Instruments Set (Empty)-PPSU	1
522100	Combination Wrench, SW11	1
522110	Ratchet Wrench, SW11	1
522120	T-Wrench, SW11	1
522140	T-Clip	1
522150	Trocar Φ 3.5, short	1
522160	Drill Sleeve 5.0/3.5, short	1
522170	Drill Sleeve 6.0/5.0, threaded, short	1
522190	Trocar Φ 3.5, long	1
522200	Drill Sleeve 5.0/3.5, long	1
522210	Drill Sleeve 6.0/5.0, threaded, long	1
522220	Drill Bit, Φ 3.5mm	1
98211	Handle for Drill Sleeve	1

Please contact your sales representative for final product list.

External Fixator (Large) Instruments Set

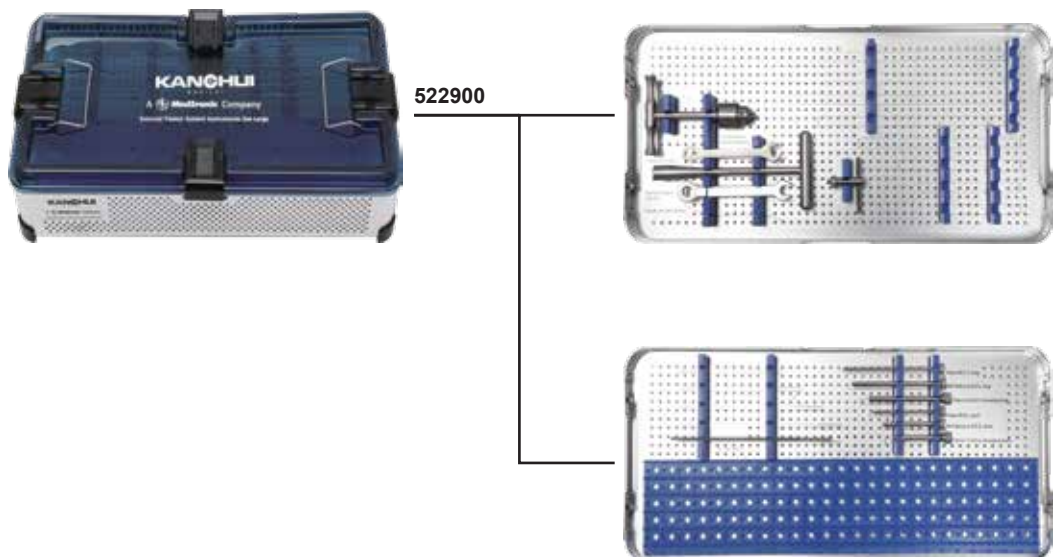

Instruments

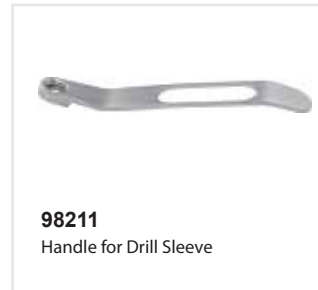
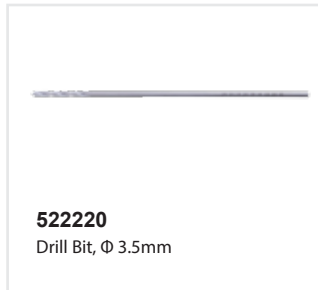
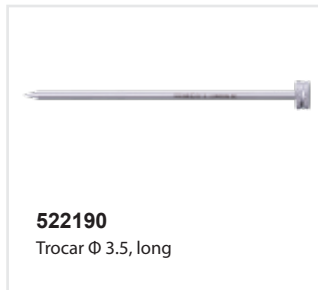
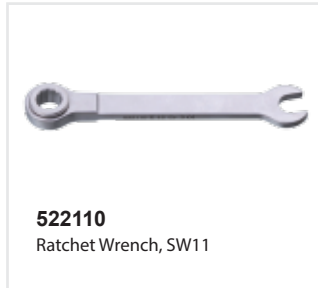

External Fixator (Medium) Instruments Set

Code	Product Description	Qty
523900	External Fixator (Medium) Instruments Set	
898365	External Fixator (Medium) Instruments Set (Empty)-PPSU	1
523100	Combination Wrench, SW8	1
523110	T-Wrench, SW8	1
522140	T-Clip	1
523120	Trocar, Φ 2.5mm	1
523130	Drill Sleeve 4.0/2.5	1
523140	Drill Sleeve Φ 4.0, with Thread	1
523150	Drill Bit, Φ 2.0mm	1
522220	Drill Bit, Φ 3.5mm	1
98211	Handle for Drill Sleeve	1

Please contact your sales representative for final product list.

External Fixator (Medium) Instruments Set



523900

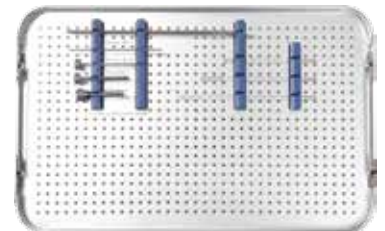
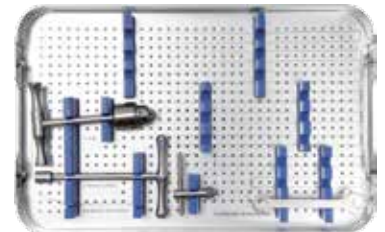



Instruments



523100
Combination Wrench, SW8



523110
T-Wrench, SW8



522140
T-Clip



523120
Trocar, Ø 2.5mm



523130
Drill Sleeve 4.0/2.5



523140
Drill Sleeve Ø 4.0, with Thread



523150
Drill Bit, Ø 2.0mm



522220
Drill Bit, Ø 3.5mm



98211
Handle for Drill Sleeve

External Fixator (Small+Mini) Instruments Set

Code	Product Description	Qty
524900	External Fixator (Small+Mini) Instruments Set	
898366	External Fixator (Small+Mini) Instruments Set (Empty)-PPSU	1
524100	Drill Sleeve 4.0/2.6	1
524110	Trocar, Φ 2.6mm	1
522140	T-Clip	1
524120	T-Wrench, SW7	1
524130	Combination Wrench, SW7	1
523150	Drill Bit, Φ 2.0mm	1
524140	Drill Bit, Φ 1.8mm	1
525100	Holder	1
525120	Combination Wrench, SW5.5	1
525130	Hex Wrench, SW5.5	1
525140	Double Drill Guide 1.6/1.2	1

Please contact your sales representative for final product list.

External Fixator (Small+Mini) Instruments Set



524900

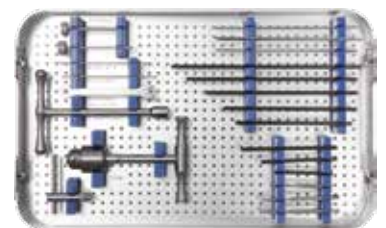
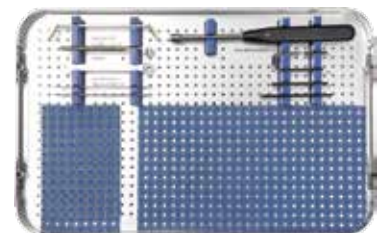

Instruments

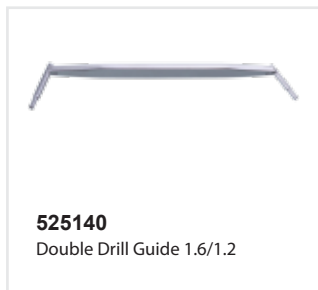
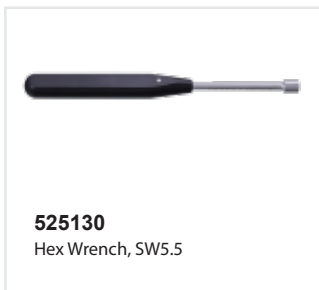
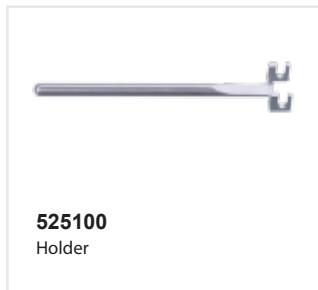
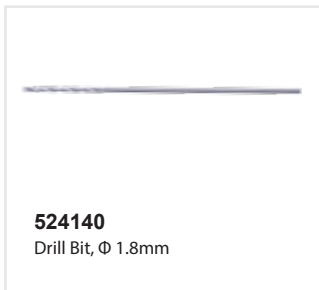
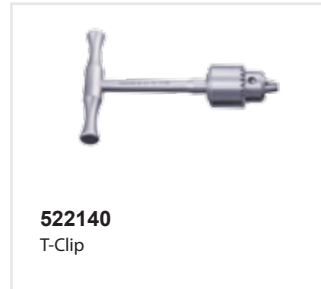

OPTIMUS External Fixator Instrument Set

Code	Product Description	Qty	Remark
549000	OPTIMUS External Fixator Instrument Set		
549010	OPTIMUS External Fixator Instrument Case	1	
549110	Allen Wrench 6mm	2	
549120	Allen Wrench 5mm	2	
549130	Allen Wrench 3mm	2	
549140	T-Wrench $\phi 6$	2	
549150	T-Wrench $\phi 4$	2	
549160	Screw Guide 80mm		Optional
549170	Screw Guide 60mm	4	
549180	Screw Guide 100mm		Optional
549190	Screw Guide 240mm		Optional
549200	Drill Guide $\phi 4.8$	1	
549210	Drill Guide $\phi 3.2$	1	
549220	Tapered Trocar, 195	1	
549230	Tapered Trocar, 240		Optional
549240	Tapered Trocar for Wrist	1	
549270	Drill Bit $\phi 2.0$ mm	2	
549260	Drill Bit $\phi 3.2$ mm	2	
549250	Drill Bit $\phi 4.8$ mm	2	
549280	Drill Guide for $\phi 2.0$ Drill Bit	2	
549290	Drill Guide for Wrist	1	
549300	Wire Tensioner	1	
549310	Combination Wrench	2	

Please contact your sales representative for final product list.



OPTIMUS External Fixator Instrument Set



524900

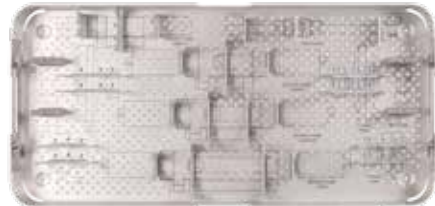
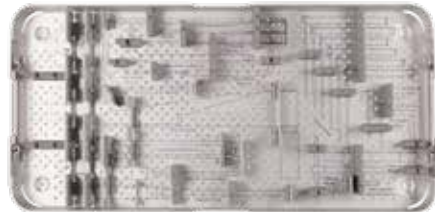
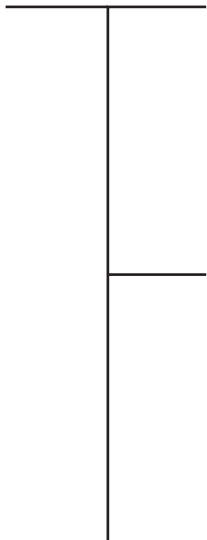

Instruments

549110/549120/549120
Allen Wrench 6mm/ 5mm/ 3mm

549140/549150
T-Wrench $\phi 6/\phi 4$

549160/ 549170/ 549180/ 549190
Screw Guide 80mm/ 60mm/
100mm/ 240mm

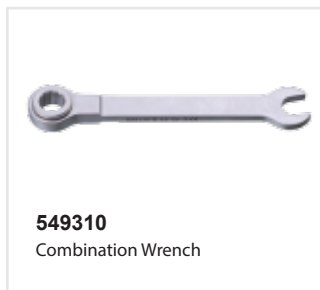
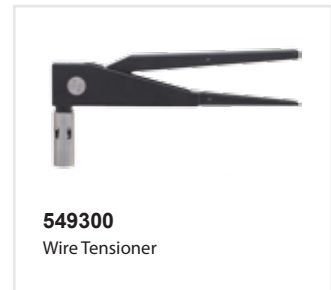
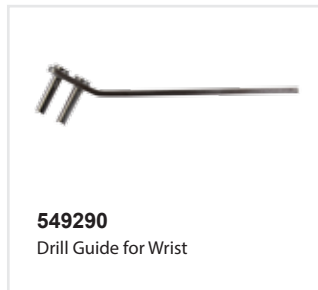
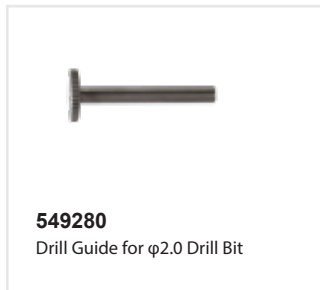
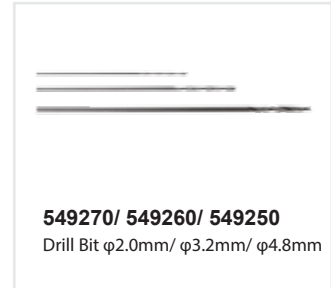
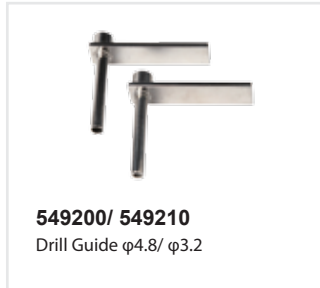

Synplate Conventional Plates System

- Synplate Modular Hand
- Synplate Small Fragment
- Synplate Large Fragment

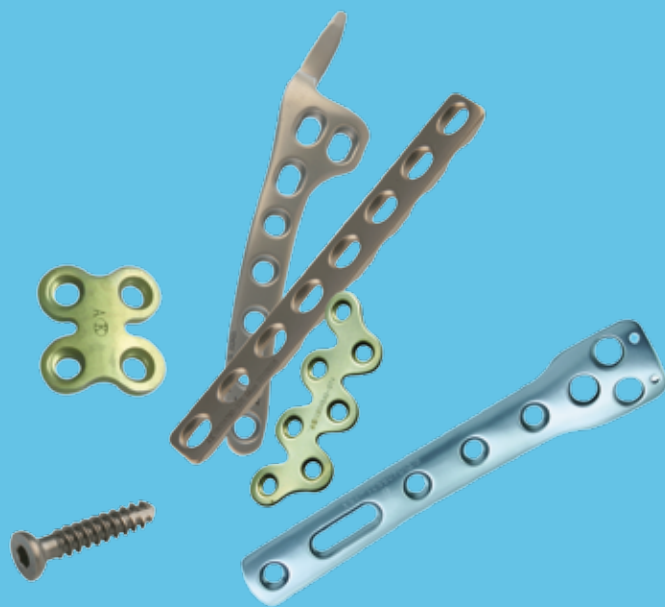

Synplate Modular Hand System

Straight Plates 1.5



Product No.	Holes	Material	Model No.
20106003	3H	PT	ZSQ02
20106004	4H	PT	ZSQ02
20106005	5H	PT	ZSQ02
20106006	6H	PT	ZSQ02
20106020	20H	PT	ZSQ03

L-Plates 1.5



Product No.	Holes	Direction	Material	Model No.
20134204	4H	Left	PT	YSQ07
20134104	4H	Right	PT	YSQ08

Angled L-Plates 1.5



Product No.	Holes	Direction	Material	Model No.
20137204	4H	Left	PT	YSQ09
20137104	4H	Right	PT	YSQ10

Short T-Plate 1.5



Product No.	Holes	Material	Model No.
20122004	4H	PT	YSQ04

Long T-Plates 1.5



Product No.	Holes	Material	Model No.
20124003	3H	PT	YSQ02
20125004	4H	PT	YSQ01

H-Plate 1.5



Product No.	Holes	Material	Model No.
20120004	4H	PT	YSQ12

Cortex Screws, fully threaded 1.5



Product No.	Length	Material	Model No.
30301106	1.5x6mm	TA	RSQ01
30301107	1.5x7mm	TA	RSQ01
30301108	1.5x8mm	TA	RSQ01
30301109	1.5x9mm	TA	RSQ01
30301110	1.5x10mm	TA	RSQ01
30301112	1.5x12mm	TA	RSQ01
30301114	1.5x14mm	TA	RSQ01

Straight Plates 2.0



Product No.	Holes	Material	Model No.
20101002	2H	PT	ZSQ02
20101003	3H	PT	ZSQ02
20101004	4H	PT	ZSQ02
20101005	5H	PT	ZSQ02
20101006	6H	PT	ZSQ02

H-Plates 2.0



Product No.	Holes	Material	Model No.
20121004	4H	PT	YSQ12
20121006	6H	PT	YSQ06

L-Plates 2.0



Product No.	Holes	Direction	Material	Model No.
20135204	4H	Left	PT	YSQ07
20135205	5H	Left	PT	YSQ07
20135104	4H	Right	PT	YSQ08
20135105	5H	Right	PT	YSQ08

Angled L-Plates 2.0



Product No.	Holes	Direction	Material	Model No.
20138204	4H	Left	PT	YSQ09
20138205	5H	Left	PT	YSQ09
20138104	4H	Right	PT	YSQ10
20138105	5H	Right	PT	YSQ10

Short T-Plate 2.0



Product No.	Holes	Material	Model No.
20123004	4H	PT	YSQ05

Long T-Plate 2.0



Product No.	Holes	Material	Model No.
20126004	4H	PT	YSQ04

T-Plates 2.0



Product No.	Holes	Material	Model No.
20130005	5H	PT	YSQ03
20130006	6H	PT	YSQ03

Cortex Screws, fully threaded 2.0



Product No.	Length	Material	Model No.
30302106	2.0x6mm	TA	RSQ01
30302108	2.0x8mm	TA	RSQ01
30302110	2.0x10mm	TA	RSQ01
30302112	2.0x12mm	TA	RSQ01
30302114	2.0x14mm	TA	RSQ01
30302116	2.0x16mm	TA	RSQ01
30302118	2.0x18mm	TA	RSQ01
30302120	2.0x20mm	TA	RSQ01

Straight Plates 2.7



Product No.	Holes	Material	Model No.
20102002	2H	PT	ZSQ02
20102003	3H	PT	ZSQ02
20102004	4H	PT	ZSQ02
20102005	5H	PT	ZSQ02
20102006	6H	PT	ZSQ02

Angled L-Plates 2.7



Product No.	Holes	Direction	Material	Model No.
20139205	5H	Left	PT	YSQ09
20139105	5H	Right	PT	YSQ10

L-Plates 2.7



Product No.	Holes	Direction	Material	Model No.
20136205	5H	Left	PT	YSQ07
20136105	5H	Right	PT	YSQ08

Mini T-Plate 2.7



Product No.	Holes	Material	Model No.
20126005	5H	PT	YSQ05



W-Plate 2.7



Product No.	Holes	Material	Model No.
20142007	7H	PT	YSQ11

Cortex screws ,fully threaded 2.7



Product No.	Length	Material	Model No.
30304106	2.7x6mm	TA	HSQ01
30304108	2.7x8mm	TA	HSQ01
30304110	2.7x10mm	TA	HSQ01
30304112	2.7x12mm	TA	HSQ01
30304114	2.7x14mm	TA	HSQ01
30304116	2.7x16mm	TA	HSQ01
30304118	2.7x18mm	TA	HSQ01
30304120	2.7x20mm	TA	HSQ01
30304122	2.7x22mm	TA	HSQ01
30304124	2.7x24mm	TA	HSQ01

Cortex screws ,partially threaded 2.7



Product No.	Length	Material	Model No.
30304210	2.7x10mm	TA	HSQ02
30304212	2.7x12mm	TA	HSQ02
30304214	2.7x14mm	TA	HSQ02
30304216	2.7x16mm	TA	HSQ02
30304220	2.7x20mm	TA	HSQ02
30304224	2.7x24mm	TA	HSQ02

Synplate Small Fragment System

Clavicular Plate 3.5, standard



Product No.	Direction	Material	Model No.
20158201	Left	PT	TBYQ15
20157101	Right	PT	TBYQ14

Clavicular Plate 3.5



Product No.	Size	Direction	Material	Model No.
20158202	2H	Left	PT	TBYQ17
20158204	4H	Left	PT	TBYQ17
20158206	6H	Left	PT	TBYQ17
20157102	2H	Right	PT	TBYQ16
20157104	4H	Right	PT	TBYQ16
20157106	6H	Right	PT	TBYQ16

Clavicular Plate II 3.5



Product No.	Size	Direction	Material	Model No.
20234202	2H	Left	PT	TBYQ23
20234203	3H	Left	PT	TBYQ23
20234205	5H	Left	PT	TBYQ23
20234207	7H	Left	PT	TBYQ23
20234102	2H	Right	PT	TBYQ22
20234103	3H	Right	PT	TBYQ22
20234105	5H	Right	PT	TBYQ22
20234107	7H	Right	PT	TBYQ22

Olecranon Plate 3.5



Product No.	Holes	Material	Model No.
20217003	3H	PT	TBYQ03
20217004	4H	PT	TBYQ03
20217005	5H	PT	TBYQ03
20217006	6H	PT	TBYQ03
20217007	7H	PT	TBYQ03
20217008	8H	PT	TBYQ03

Cloverleaf Plate 3.5



Product No.	Holes	Material	Model No.
20143003	3H	PT	YSQ19
20143004	4H	PT	YSQ19
20143005	5H	PT	YSQ19
20143006	6H	PT	YSQ19
20143008	8H	PT	YSQ19

T-Plate 3.5, right angled



Product No.	Holes	Material	Model No.
20127003	3H	PT	YSQ01
20127004	4H	PT	YSQ01
20127005	5H	PT	YSQ01

T-Plate 3.5, oblique angled



Product No.	Holes	Material	Model No.
20129003	3H	PT	YSQ04
20129004	4H	PT	YSQ04
20129005	5H	PT	YSQ04

Y-Plate 3.5



Product No.	Holes	Material	Model No.
20212003	3H	PT	TBYQ06
20212004	4H	PT	TBYQ06
20212005	5H	PT	TBYQ06
20212006	6H	PT	TBYQ06
20212007	7H	PT	TBYQ06

Lateral Column Plate 3.5



Product No.	Size	Direction	Material	Model No.
20214203	3H	Left	PT	TBYQ05
20214205	5H	Left	PT	TBYQ05
20214103	3H	Right	PT	TBYQ04
20214105	5H	Right	PT	TBYQ04

Medial Column Plate 3.5



Product No.	Holes	Material	Model No.
20216003	3H	PT	TBYQ01
20216004	4H	PT	TBYQ01
20216005	5H	PT	TBYQ01

Proximal Humeral Plate 3.5



Product No.	Direction	Holes	Material	Model No.
20218203	Left	3H	PT	TBYQ08
20218205	Left	5H	PT	TBYQ08
20218207	Left	7H	PT	TBYQ08
20218209	Left	9H	PT	TBYQ08
20218211	Left	11H	PT	TBYQ08
20218213	Left	13H	PT	TBYQ08
20218103	Right	3H	PT	TBYQ07
20218105	Right	5H	PT	TBYQ07
20218107	Right	7H	PT	TBYQ07
20218109	Right	9H	PT	TBYQ07
20218111	Right	11H	PT	TBYQ07
20218113	Right	13H	PT	TBYQ07

Distal Dorsal Radius Delta Plate



Product No.	Size	Direction	Material	Model No.
20229203	3H	Left	PT	TJYQ06
20229205	5H	Left	PT	TJYQ06
20229207	7H	Left	PT	TJYQ06
20229103	3H	Right	PT	TJYQ07
20229105	5H	Right	PT	TJYQ07
20229107	7H	Right	PT	TJYQ07

Distal Dorsal Radius T-Plate



Product No.	Size	Direction	Material	Model No.
20230203	3H	Left	PT	TJYQ09
20230205	5H	Left	PT	TJYQ09
20230207	7H	Left	PT	TJYQ09
20230103	3H	Right	PT	TJYQ08
20230105	5H	Right	PT	TJYQ08
20230107	7H	Right	PT	TJYQ08

Reconstruction Plate 3.5



Product No.	Holes	Material	Model No.
20116004	4H	PT	ZSQ12
20116005	5H	PT	ZSQ12
20116006	6H	PT	ZSQ12
20116007	7H	PT	ZSQ12
20116008	8H	PT	ZSQ12
20116009	9H	PT	ZSQ12
20116010	10H	PT	ZSQ12
20116011	11H	PT	ZSQ12
20116012	12H	PT	ZSQ12
20116014	14H	PT	ZSQ12
20116016	16H	PT	ZSQ12
20116018	18H	PT	ZSQ12

Limited Contact Dynamic Compression Plate 3.5



Product No.	Holes	Material	Model No.
20109004	4H	PT	ZSQ06
20109005	5H	PT	ZSQ06
20109006	6H	PT	ZSQ06
20109007	7H	PT	ZSQ06
20109008	8H	PT	ZSQ06
20109009	9H	PT	ZSQ06
20109010	10H	PT	ZSQ06

Dynamic Compression Plate 3.5



Product No.	Holes	Material	Model No.
20103004	4H	PT	ZSQ07
20103005	5H	PT	ZSQ07
20103006	6H	PT	ZSQ07
20103007	7H	PT	ZSQ07
20103008	8H	PT	ZSQ07
20103009	9H	PT	ZSQ07
20103010	10H	PT	ZSQ07
20103012	12H	PT	ZSQ07

One-Third Tubular Plate 3.5



Product No.	Holes	Material	Model No.
20108004	4H	PT	ZSQ02
20108005	5H	PT	ZSQ02
20108006	6H	PT	ZSQ02
20108007	7H	PT	ZSQ02
20108008	8H	PT	ZSQ02
20108009	9H	PT	ZSQ02
20108010	10H	PT	ZSQ02
20108011	11H	PT	ZSQ02
20108012	12H	PT	ZSQ02

S-reconstruction Plate 3.5



Product No.	Direction	Holes	Material	Model No.
20232206	Left	6H	PT	TBYQ19
20232207	Left	7H	PT	TBYQ19
20232208	Left	8H	PT	TBYQ19
20232209	Left	9H	PT	TBYQ19
20232210	Left	10H	PT	TBYQ19
20232212	Left	12H	PT	TBYQ19
20232106	Right	6H	PT	TBYQ18
20232107	Right	7H	PT	TBYQ18
20232108	Right	8H	PT	TBYQ18
20232109	Right	9H	PT	TBYQ18
20232110	Right	10H	PT	TBYQ18
20232112	Right	12H	PT	TBYQ18

Curved Pelvic Plate 3.5



Product No.	Holes	Material	Model No.
20144108	8H	PT	YSQ20
20144110	10H	PT	YSQ20
20144112	12H	PT	YSQ20
20144114	14H	PT	YSQ20
20144116	16H	PT	YSQ20

Pelvic Posterior Column Plate, 10H



Product No.	Length	Material	Model No.
24236000	103mm	PT	YSQ37
24237000	102mm	PT	YSQ37
24238000	104mm	PT	YSQ37

Calcaneal Plate, long



Product No.	Holes	Material	Model No.
20205013	13H	PT	TGQ01
20205015	15H	PT	TGQ01

Calcaneal Plate, short



Product No.	Holes	Material	Model No.
20206011	11H	PT	TGQ01
20206013	13H	PT	TGQ01

Distal Lateral Fibular Plate 3.5



Product No.	Holes	Material	Model No.
20235005	5H	PT	TBYQ11
20235006	6H	PT	TBYQ11
20235007	7H	PT	TBYQ11
20235008	8H	PT	TBYQ11
20235009	9H	PT	TBYQ11
20235010	10H	PT	TBYQ11
20235011	11H	PT	TBYQ11
20235012	12H	PT	TBYQ11
20235013	13H	PT	TBYQ11
20235014	14H	PT	TBYQ11

L-Buttress Plates 4.5



Product No.	Size	Direction	Material	Model No.
20222204	4H	Left	PT	TJYQ05
20222206	6H	Left	PT	TJYQ05
20222208	8H	Left	PT	TJYQ05
20222104	4H	Right	PT	TJYQ04
20222106	6H	Right	PT	TJYQ04
20222108	8H	Right	PT	TJYQ04

Proximal Lateral Femoral Plates 4.5



Product No.	Size	Direction	Material	Model No.
20220207	7H	Left	PT	TGYQ09
20220209	9H	Left	PT	TGYQ09
20220211	11H	Left	PT	TGYQ09
20220213	13H	Left	PT	TGYQ09
20220107	7H	Right	PT	TGYQ09
20220109	9H	Right	PT	TGYQ09
20220111	11H	Right	PT	TGYQ09
20220113	13H	Right	PT	TGYQ09

Distal Lateral Femoral Plates 4.5



Product No.	Size	Direction	Material	Model No.
20219207	7H	Left	PT	TGYQ05
20219209	9H	Left	PT	TGYQ05
20219211	11H	Left	PT	TGYQ05
20219213	13H	Left	PT	TGYQ05
20219107	7H	Right	PT	TGYQ06
20219109	9H	Right	PT	TGYQ06
20219111	11H	Right	PT	TGYQ06
20219113	13H	Right	PT	TGYQ06

Distal Medial Femoral Plates 4.5



Product No.	Size	Direction	Material	Model No.
20221205	5H	Left	PT	TGYQ06
20221207	7H	Left	PT	TGYQ06
20221209	9H	Left	PT	TGYQ06
20221105	5H	Right	PT	TGYQ05
20221107	7H	Right	PT	TGYQ05
20221109	9H	Right	PT	TGYQ05

Distal Lateral Tibial Plates 4.5 II



Product No.	Size	Direction	Material	Model No.
20233202	5+2H	Left	PT	TJYQ17
20233204	5+4H	Left	PT	TJYQ17
20233206	5+6H	Left	PT	TJYQ17
20233208	5+8H	Left	PT	TJYQ17
20233102	5+2H	Right	PT	TJYQ16
20233104	5+4H	Right	PT	TJYQ16
20233106	5+6H	Right	PT	TJYQ16
20233108	5+8H	Right	PT	TJYQ16

Distal Medial Tibial Plates 4.5



Product No.	Size	Direction	Material	Model No.
20207205	5H	Left	PT	TJYQ17
20207207	7H	Left	PT	TJYQ17
20207209	9H	Left	PT	TJYQ17
20207211	11H	Left	PT	TJYQ17
20207213	13H	Left	PT	TJYQ17
20207105	5H	Right	PT	TJYQ16
20207107	7H	Right	PT	TJYQ16
20207109	9H	Right	PT	TJYQ16
20207111	11H	Right	PT	TJYQ16
20207113	13H	Right	PT	TJYQ16

Distal Medial Tibial Plates 4.5 II



Product No.	Size	Direction	Material	Model No.
20228205	5H	Left	PT	TJYQ12
20228207	7H	Left	PT	TJYQ12
20228209	9H	Left	PT	TJYQ12
20228105	5H	Right	PT	TJYQ13
20228107	7H	Right	PT	TJYQ13
20228109	9H	Right	PT	TJYQ13

Lateral Tibial Head Buttress Plates 4.5



Product No.	Size	Direction	Material	Model No.
20203205	5H	Left	PT	TJYQ02
20203207	7H	Left	PT	TJYQ02
20203209	9H	Left	PT	TJYQ02
20203211	11H	Left	PT	TJYQ02
20203213	13H	Left	PT	TJYQ02
20203105	5H	Right	PT	TJYQ01
20203107	7H	Right	PT	TJYQ01
20203109	9H	Right	PT	TJYQ01
20203111	11H	Right	PT	TJYQ01
20203113	13H	Right	PT	TJYQ01

T-Buttress Plates 4.5, single-curved



Product No.	Holes	Material	Model No.
20131004	4H	PT	YSQ06
20131005	5H	PT	YSQ06
20131006	6H	PT	YSQ06
20131008	8H	PT	YSQ06
20131010	10H	PT	YSQ06
20131012	12H	PT	YSQ06

T-Buttress Plates 4.5, double-curved



Product No.	Holes	Material	Model No.
20132004	4H	PT	YSQ06
20132005	5H	PT	YSQ06
20132006	6H	PT	YSQ06
20132008	8H	PT	YSQ06

Condylar Buttress Plates 4.5



Product No.	Size	Direction	Material	Model No.
20202207	7H	Left	PT	TGYQ02
20202209	9H	Left	PT	TGYQ02
20202211	11H	Left	PT	TGYQ02
20202213	13H	Left	PT	TGYQ02
20202107	7H	Right	PT	TGYQ01
20202109	9H	Right	PT	TGYQ01
20202111	11H	Right	PT	TGYQ01
20202113	13H	Right	PT	TGYQ01

Condylar Buttress Plates 4.5, curved



Product No.	Size	Direction	Material	Model No.
20208207	7H	Left	PT	TGYQ03
20208209	9H	Left	PT	TGYQ03
20208211	11H	Left	PT	TGYQ03
20208213	13H	Left	PT	TGYQ03
20208107	7H	Right	PT	TGYQ04
20208109	9H	Right	PT	TGYQ04
20208111	11H	Right	PT	TGYQ04
20208113	13H	Right	PT	TGYQ04

Limited Contact Dynamic Compression Plates 4.5, narrow



Product No.	Holes	Material	Model No.
20110004	4H	PT	ZSQ06
20110005	5H	PT	ZSQ06
20110006	6H	PT	ZSQ06
20110007	7H	PT	ZSQ06
20110008	8H	PT	ZSQ06
20110009	9H	PT	ZSQ06
20110010	10H	PT	ZSQ06
20110012	12H	PT	ZSQ06
20110014	14H	PT	ZSQ06
20110016	16H	PT	ZSQ06

Limited Contact Dynamic Compression Plates 4.5, broad



Product No.	Holes	Material	Model No.
20111005	5H	PT	ZSQ06
20111006	6H	PT	ZSQ06
20111007	7H	PT	ZSQ06
20111008	8H	PT	ZSQ06
20111009	9H	PT	ZSQ06
20111010	10H	PT	ZSQ06
20111012	12H	PT	ZSQ06
20111014	14H	PT	ZSQ06
20111016	16H	PT	ZSQ06

Dynamic Compression Plates 4.5, narrow



Product No.	Holes	Material	Model No.
20104004	4H	PT	ZSQ07
20104005	5H	PT	ZSQ07
20104006	6H	PT	ZSQ07
20104007	7H	PT	ZSQ07
20104008	8H	PT	ZSQ07
20104009	9H	PT	ZSQ07
20104010	10H	PT	ZSQ07
20104012	12H	PT	ZSQ07

Dynamic Compression Plates 4.5, broad



Product No.	Holes	Material	Model No.
20105005	5H	PT	ZSQ08
20105006	6H	PT	ZSQ08
20105007	7H	PT	ZSQ08
20105008	8H	PT	ZSQ08
20105009	9H	PT	ZSQ08
20105010	10H	PT	ZSQ08
20105012	12H	PT	ZSQ08
20105014	14H	PT	ZSQ08

Synplate Modular Hand Instruments Set

Code	Product Description	Qty
01900	Synplate Modular Hand Instruments Set	
898342	Synplate Modular Hand Instruments Set (Empty)-PPSU	1
01103	Handle with Quick Coupling	1
01104	Depth Gauge, 40mm	1
01214	Bending Iron	2
01215	Retractor, width 6mm	1
01216	Retractor, width 8mm	1
01217	Retractor, width 15mm	1
01218	Sharp Hook	1
01219	Periosteal Elevator, width 5mm	1
01220	Screw Forceps	1
01221	Bending Pliers for Finger Plates	1
01123	Reduction Forceps with Points	1
01124	Reduction Forceps with Points, toothed	1
01125	Plate Holder	1
01232	Periosteal Elevator, width 3mm	1
01222	Bending and Cutting Pliers	1
01026	1.5mm Modular Hand Implants Case (Empty)	1
00101	Drill Bit, Φ 1.1mm	2
00102	Drill Bit, Φ 1.5mm	1
01210	Screwdriver 1.5	1
01229	Universal Drill Guides 1.5	1
01205	Tap, Φ 1.5mm	1
01027	2.0mm Modular Hand Instruments Set (Empty)	1
00102	Drill Bit, Φ 1.5mm	2
00203	Drill Bit, Φ 2.0mm	1
01212	Easyout, small	1
01230	Universal Drill Guide 2.0	1
01206	Tap, Φ 2.0mm	1
01211	Screwdriver 2.0	1
01028	2.7mm Modular Hand Instruments Set (Empty)	1
00203	Drill Bit, Φ 2.0mm	2
00205	Drill Bit, Φ 2.7mm	1
01208	Mini Countersink	1



Code	Product Description	Qty
01209	Screwdriver 2.7	1
01207	Tap, Φ 2.7mm	1
01213	Easyout, medium	1
01231	Universal Drill Guide 2.7	1

Please contact your sales representative for final product list.

Synplate Modular Hand Instruments Set



01900

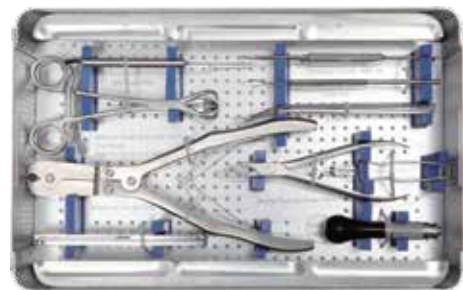

01026

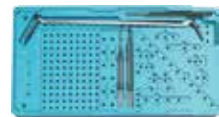

01027



01028





Instruments

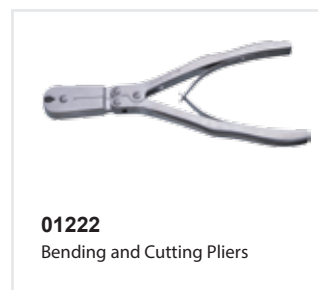
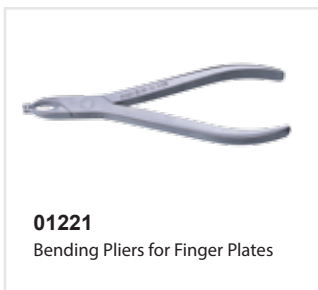
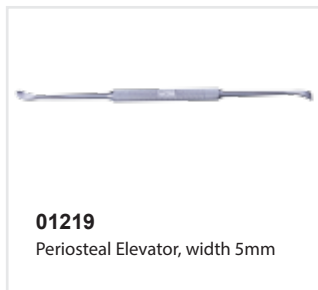
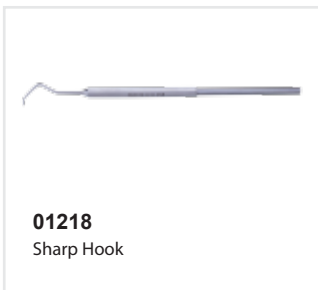
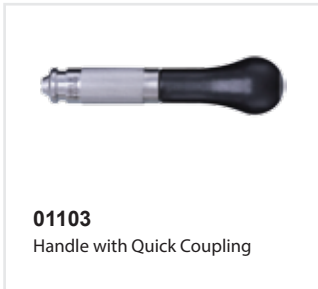

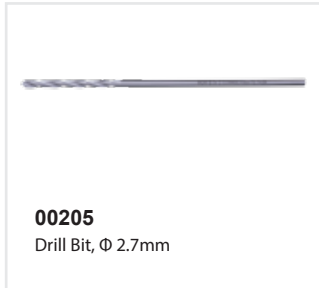
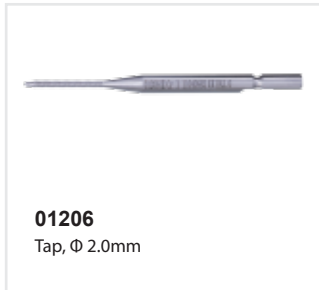
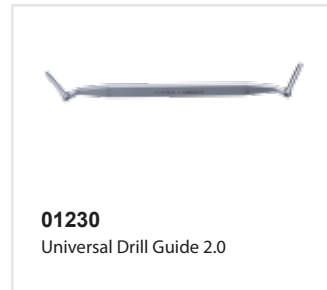
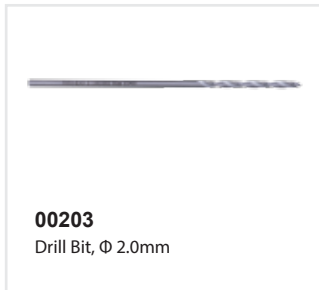
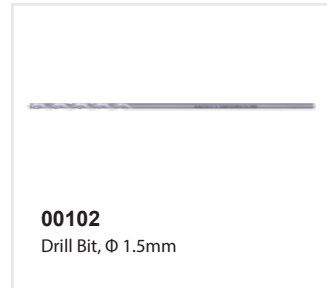
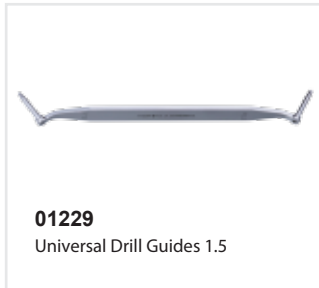
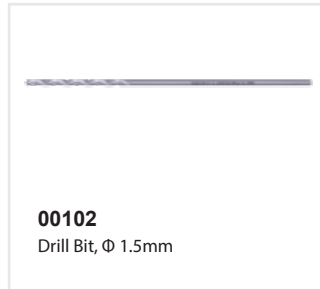

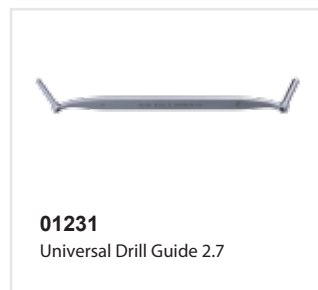
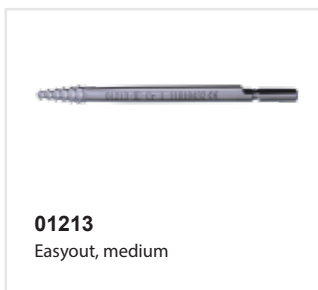
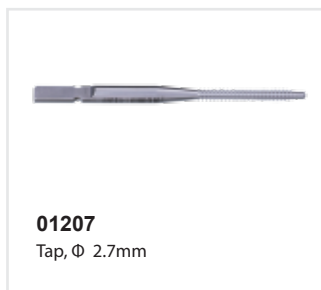

Synplate Small Fragment Instruments Set

Code	Product Description	Qty
201900	Synplate Small Fragment Instruments Set	
898179	Screw Case-PPSU	1
898343	Synplate Small Fragment Instruments Set (Empty) -PPSU	1
010030	Drill Bit, Φ 3.5mm	2
010010	Drill Bit, Φ 2.5mm	2
201100	Drill Sleeve 2.0	1
201110	Drill Sleeve 2.5	1
201120	Double Drill Guide 3.5/2.5	1
201130	Double Drill Sleeve 2.5	1
201140	Hex Screwdriver	1
020010	Tap, Φ 3.5mm	1
030100	T-handle with Quick Coupling	1
020020	Tap, Φ 4.0mm	1
201150	Trephine	1
201170	Bone Holding Forceps, self-centering	2
201180	Reduction Forceps, serrated jaws, small	1
201190	Reduction Forceps with Points, small	1
201200	Depth Gauge, 60mm	1
201210	Easyout	1
201220	Countersink	1
201230	Periosteal Elevator, Round	1
201240	Periosteal Elevator, Straight	1
201250	Screw Holding Sleeve for Hex Screw	1
201160	Bending Irons	2
02037	Templates	1

Please contact your sales representative for final product list.



Synplate Small Fragment Instruments Set

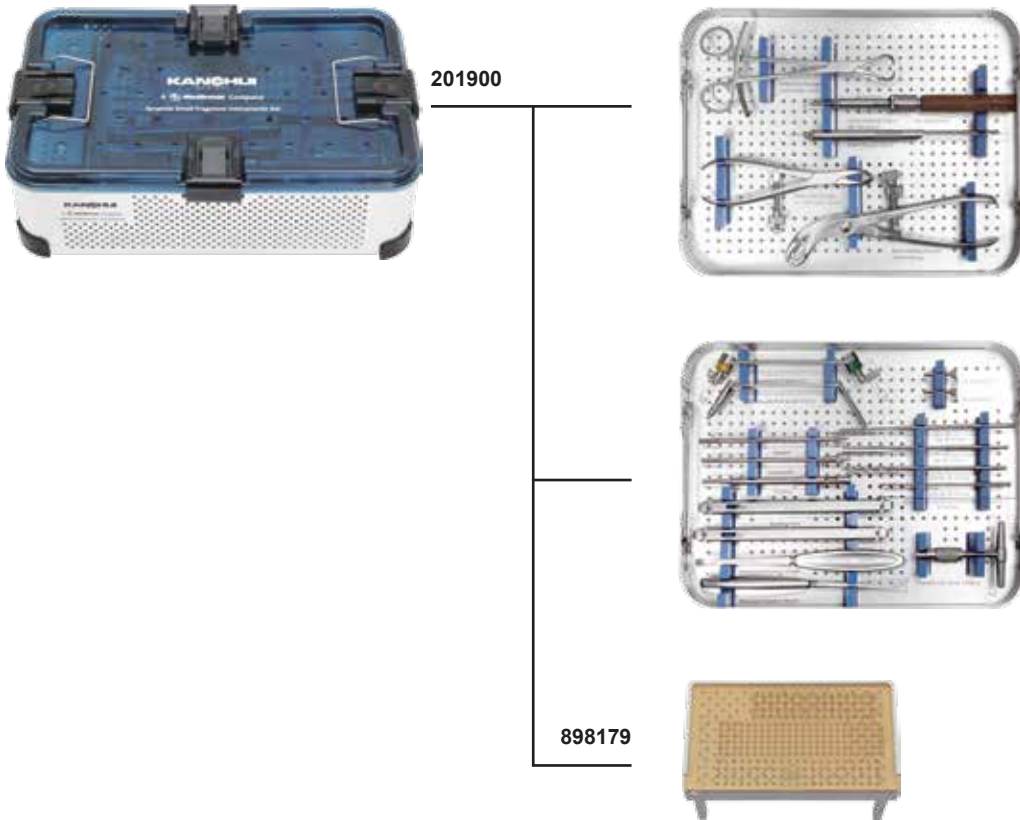

Instruments



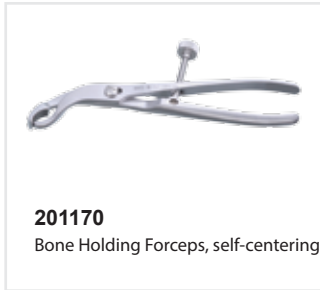
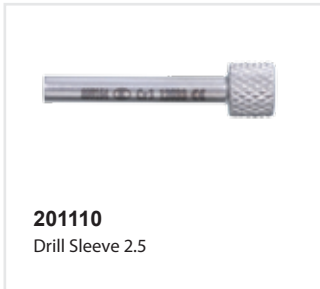



201240
Periosteal Elevator, Straight



201250
Screw Holding Sleeve for Hex Screw



201160
Bending Irons

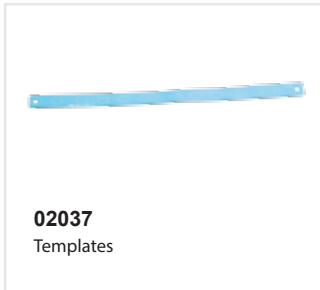

02037
Templates



Synplate Large Fragment Instruments Set

Code	Product Description	Qty
206900	Synplate Large Fragment System Instruments Set	
898183	Screw Case-PPSU	1
898344	Synplate Large Fragment System Instruments Set (Empty)-PPSU	1
206100	Double Drill Sleeve 3.2	1
206110	Double Drill Guide 6.5/3.2	1
206120	Double Drill Guide 4.5/3.2	1
206140	Easyout	1
010040	Drill Bit, Φ 4.5mm	2
010020	Drill Bit, Φ 3.2mm	2
206150	Reduction Forceps, serrated jaws, large	1
206160	Reduction Forceps with Points, large	1
206170	Depth Gauge, 90mm	1
206180	Periosteal Elevator, Round	1
206190	Periosteal Elevator, Straight	1
206200	Countersink	1
030100	T-handle with Quick Coupling	1
206210	Drill Sleeve 3.2	1
206220	Drill Guide, pointed	1
206230	Drill Sleeve 4.5	1
206240	Trephine	1
020040	Tap, Φ 6.5mm	1
020030	Tap, Φ 4.5mm	1
206280	Hex Screwdriver	1
206290	Bone Holding Forceps, self-centering	2
206300	Screw Holding Sleeve for Hex Screw	1
206320	Bending Irons, left	1
206340	Bending Irons, right	1
03035	Templates	1

Please contact your sales representative for final product list.



Synplate Large Fragment Instruments Set



206900

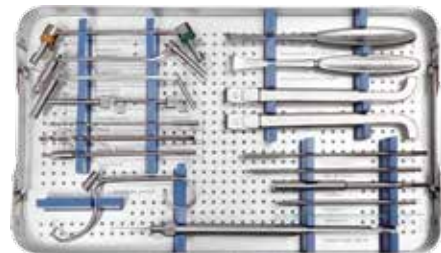
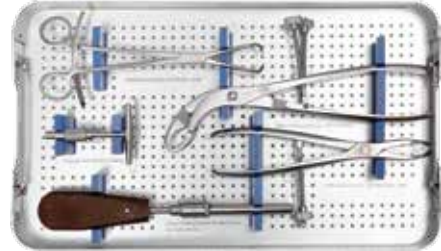

898183



Instruments

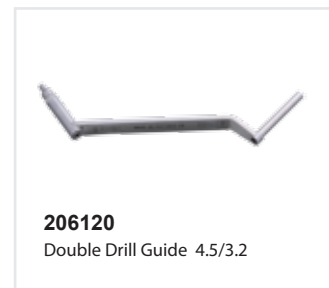
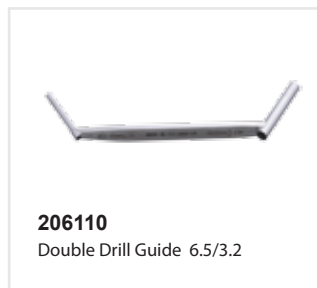

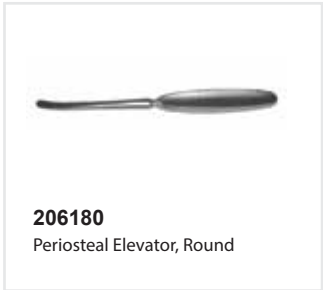
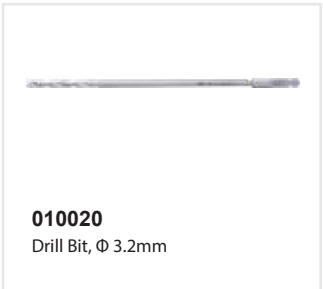
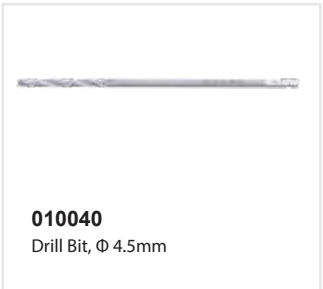

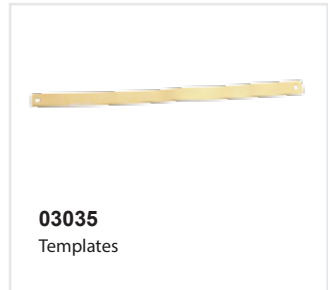

Pins & Wires System

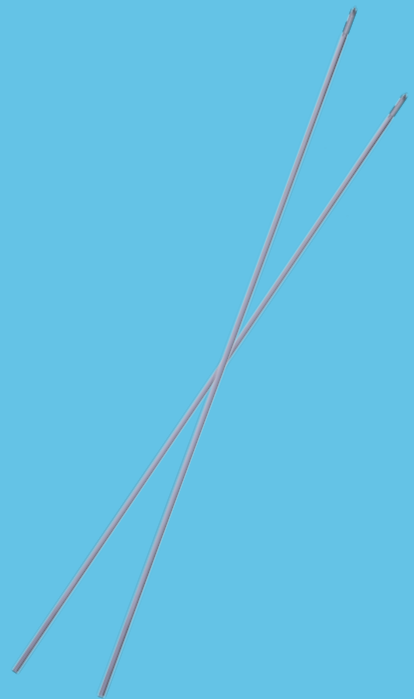

Wires&Pins System

Trocar K wires



Product No.	Size	Material	Model No.
10701030	0.8x30	SS	GZZh01YA
10701050	0.8x50	SS	GZZh01YA
10701070	0.8x70	SS	GZZh01YA
10701090	0.8x90	SS	GZZh01YA
10701110	0.8x110	SS	GZZh01YA
10701120	0.8x120	SS	GZZh01YA
10701300	0.8x300	SS	GZZh01YA
10702050	1.0x50	SS	GZZh01YA
10702090	1.0x90	SS	GZZh01YA
10702110	1.0x110	SS	GZZh01YA
10702120	1.0x120	SS	GZZh01YA
10702150	1.0x150	SS	GZZh01YA
10702250	1.0x250	SS	GZZh01YA
10702300	1.0x300	SS	GZZh01YA
10703110	1.2x110	SS	GZZh01YA
10703120	1.2x120	SS	GZZh01YA
10703150	1.2x150	SS	GZZh01YA
10703200	1.2x200	SS	GZZh01YA
10703250	1.2x250	SS	GZZh01YA
10704100	1.5x100	SS	GZZh01YA
10704120	1.5x120	SS	GZZh01YA
10704150	1.5x150	SS	GZZh01YA
10704200	1.5x200	SS	GZZh01YA
10704220	1.5x220	SS	GZZh01YA
10704240	1.5x240	SS	GZZh01YA
10704250	1.5x250	SS	GZZh01YA
10704300	1.5x300	SS	GZZh01YA
10705150	2.0x150	SS	GZZh01YA
10705180	2.0x180	SS	GZZh01YA
10705200	2.0x200	SS	GZZh01YA
10705220	2.0x220	SS	GZZh01YA
10705250	2.0x250	SS	GZZh01YA
10705300	2.0x300	SS	GZZh01YA



Product No.	Size	Material	Model No.
10706150	2.5x150	SS	GZZh01YA
10706200	2.5x200	SS	GZZh01YA
10706220	2.5x220	SS	GZZh01YA
10706250	2.5x250	SS	GZZh01YA
10706280	2.5x280	SS	GZZh01YA
10706300	2.5x300	SS	GZZh01YA
10707220	3.0x220	SS	GZZh01YA
10707250	3.0x250	SS	GZZh01YA
10707300	3.0x300	SS	GZZh01YA
10708280	3.5x280	SS	GZZh01YA
10708300	3.5x300	SS	GZZh01YA
10709250	4.0x250	SS	GZZh01YA
10709300	4.0x300	SS	GZZh01YA
10710240	4.5x240	SS	GZZh01YA
10710300	4.5x300	SS	GZZh01YA

Bayonet triangle K wires



Product No.	Size	Material	Model No.
10717250	4.5x250	SS	GZB01SJB

Trocar triangle K wires



Product No.	Size	Material	Model No.
10721250	4.5x250	SS	GZZh01SJB

Threaded Pin



Product No.	Size	Material	Model No.
10726180	1.6x180	SS	GZLW02YA
10727230	2.5x230	SS	GZLW02YA
10727280	2.5x280	SS	GZLW02YA
10727300	2.5x300	SS	GZLW02YA

Cranial Maxillofacial Plates & Screws System

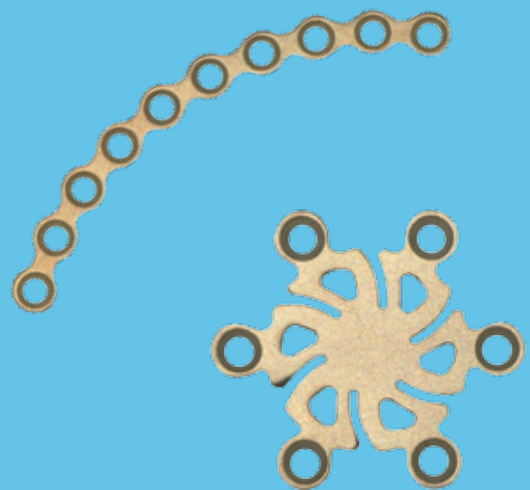

1.5mm System

Plates

Straight Plates, 0.6mm thickness

Product No.	Size	Material	Model No.
23201004	4H	PT	ZEZ03
23201006	6H	PT	ZEZ03
23201018	18H	PT	ZEZ03



Straight Plates, 0.6mm thickness, with stem

Product No.	Size	Material	Model No.
23202002	2H	PT	ZEZ04
23202004	4H	PT	ZEZ02
23202006	6H	PT	ZEZ01



Orbital Plates, 0.6mm thickness, curved

Product No.	Size	Material	Model No.
23203008	8H	PT	YEZ69
23203010	10H	PT	YEZ69
23203012	12H	PT	YEZ69



L-Plate, 0.6mm thickness, with stem

Product No.	Size	Direction	Material	Model No.
23204205	5H	Left	PT	YEZ25
23204105	5H	Right	PT	YEZ24



Y-Plate, 0.6mm thickness, with long stem

Product No.	Size	Material	Model No.
23205006	6H	PT	YEZ07



Double Y-Plate, 0.6mm thickness, with stem

Product No.	Size	Material	Model No.
23206006	6H	PT	YEZ34



Burr Hole Cover, 0.6mm thickness

Product No.	Size	Material	Model No.
23207006	6H	PT	YEZ61



1.5mm Mesh Plates, 0.4mm thickness

Product No.	Size	Material	Model No.
23209040	45x55mm	PT	YEZ57
23209100	105x105mm	PT	YEZ57

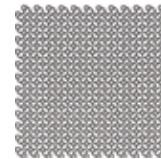

1.5mm Mesh Plates, 0.6mm thickness

Product No.	Size	Material	Model No.
23208040	45x55mm	PT	YEZ57
23208070	70x80mm	PT	YEZ57
23208100	105x105mm	PT	YEZ57

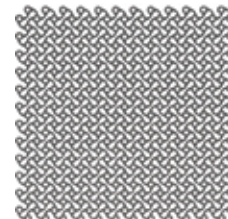

1.5mm Screws, self-drilling

Product No.	Length	Material	Model No.
30364004	4mm	TA	CEQ01
30364005	5mm	TA	CEQ01
30364006	6mm	TA	CEQ01
30364008	8mm	TA	CEQ01



1.5mm Screws, self-tapping

Product No.	Length	Material	Model No.			
30365004	4mm	TA	CEQ01			
30365005	5mm	TA	CEQ01			
30365006	6mm	TA </tr <tr> <td>30365008</td> <td>8mm</td> <td>TA</td> <td>CEQ01</td> </tr>	30365008	8mm	TA	CEQ01
30365008	8mm	TA	CEQ01			



1.7mm Revision Screws, self-tapping

Product No.	Length	Material	Model No.
30371004	4mm	TA	CEQ01
30371005	5mm	TA	CEQ01
30371006	6mm	TA	CEQ01
30371008	8mm	TA	CEQ01



2.0mm System

Plates

Straight Plates, 1.0mm thickness

Product No.	Size	Material	Model No.
23211004	4H	PT	ZEZ03
23211006	6H	PT	ZEZ03
23211018	18H	PT	ZEZ03



Straight Plates, 1.0mm thickness, with stem

Product No.	Size	Material	Model No.
23212002	2H	PT	ZEZ04
23212004	4H	PT	ZEZ02
23212006	6H	PT	ZEZ01



L-Plates, 1.0mm thickness, with stem

Product No.	Size	Direction	Material	Model No.
23213205	5H	Left	PT	YEZ25
23213105	5H	Right	PT	YEZ24



Y-Plate, 1.0mm thickness, with long stem

Product No.	Size	Material	Model No.
23214006	6H	PT	YEZ07



Double Y-Plate, 1.0mm thickness, with stem

Product No.	Size	Material	Model No.
23215006	6H	PT	YEZ34



2.0mm Mesh Plates, 1.0mm thickness

Product No.	Size	Material	Model No.
23217060	60x80mm	PT	YEZ57
23217100	100x100mm	PT	YEZ57
23217120	120x120mm	PT	YEZ57
23217150	150x150mm	PT	YEZ57
23217200	205x205mm	PT	YEZ57

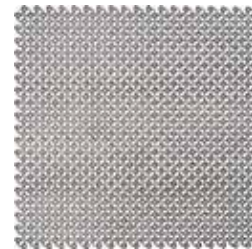

Screws

2.0mm Screws, self-drilling

Product No.	Length	Material	Model No.
30366006	6mm	TA	CEQ01
30366008	8mm	TA	CEQ01
30366010	10mm	TA	CEQ01
30366012	12mm	TA	CEQ01



2.0mm Screws, self-tapping

Product No.	Length	Material	Model No.
30367006	6mm	TA	CEQ01
30367008	8mm	TA	CEQ01
30367010	10mm	TA	CEQ01
30367012	12mm	TA	CEQ01



2.4mm Revision Screws, self tapping

Product No.	Length	Material	Model No.
30372006	6mm	TA	CEQ01
30372008	8mm	TA	CEQ01
30372010	10mm	TA	CEQ01
30372012	12mm	TA	CEQ01



2.4mm System

Plates

Straight Mandible Reconstruction Plates, 2.5mm thickness

Product No.	Size	Material	Model No.
23223008	8H	PT	ZEZ08
23223012	12H	PT	ZEZ08
23223024	24H	PT	ZEZ08



Mandible Reconstruction L-Plates, 2.5mm thickness

Product No.	Size	Direction	Material	Model No.
23224210	5+10H	Left	PT	YEZ23
23224110	5+10H	Right	PT	YEZ22
23224214	6+14H	Left	PT	YEZ23
23224114	6+14H	Right	PT	YEZ22
23224218	6+18H	Left	PT	YEZ23
23224118	6+18H	Right	PT	YEZ22



Screws

2.4mm Mandible Screws, self tapping

Product No.	Length	Material	Model No.
30369006	6mm	TA	CEQ01
30369008	8mm	TA	CEQ01
30369010	10mm	TA	CEQ01
30369012	12mm	TA	CEQ01
30369014	14mm	TA	CEQ01
30369016	16mm	TA	CEQ01





2.4mm Mandible Screws, self drilling

Product No.	Length	Material	Model No.
30370006	6mm	TA	CEQ01
30370008	8mm	TA	CEQ01
30370010	10mm	TA	CEQ01
30370012	12mm	TA	CEQ01
30370014	14mm	TA	CEQ01
30370016	16mm	TA	CEQ01



2.7mm Mandible Revision Screws

Product No.	Length	Material	Model No.
30373006	6mm	TA	CEQ01
30373008	8mm	TA	CEQ01
30373010	10mm	TA	CEQ01
30373012	12mm	TA	CEQ01
30373014	14mm	TA	CEQ01
30373016	16mm	TA	CEQ01



Cranial Maxillofacial Plates Instruments Set

Code	Product Description	Qty
217900	Cranial Maxillofacial Plates System Instruments Set	
898341	Cranial Maxillofacial Plates System Instruments Set(Empty)-PPSU	1
216100	Handle, with Mini Quick Coupling	2
217490	Bending-Cutting Pliers	1
217500	Universal Pliers, pointed, for Plates 1.0 to 2.0 (left)	1
217510	Universal Pliers, pointed, for Plates 1.0 to 2.0 (right)	1
217100	Double Drill Sleeve 1.8/1.5	1
217110	Double Drill Sleeve 1.5/1.1	1
217530	Holding Forceps for Cortex Screws Φ 1.0 to 2.0mm	1
216160	Holding Forceps for Plates 1.0 to 2.0	1
216170	Depth Gauge	1
216180	Plate Holding Instruments, for Plates 1.5	1
216190	Plate Holding Instruments, for Plates 2.0	1
217201	Implants Case, 1.5mm (Empty)	1
216310	Drill Bit Φ 1.1mm with Stop, Drilling Depth 4mm	1
216320	Drill Bit Φ 1.1mm with Stop, Drilling Depth 6mm	1
216330	Drill Bit Φ 1.1mm with Stop, Drilling Depth 8mm	1
216360	Screwdriver Shafts, length 80mm	2
216370	Drill Bit Φ 1.1mm with Stop, Drilling Depth 80mm	1
217301	Implants Case, 2.0mm (Empty)	1
217310	Drill Bit Φ 1.5mm with Stop, Drilling Depth 6mm	1
217320	Drill Bit Φ 1.5mm with Stop, Drilling Depth 8mm	1
217330	Drill Bit Φ 1.5mm with Stop, Drilling Depth 12mm	1
217340	Drill Bit Φ 1.5mm with Stop, Drilling Depth 85mm	1
216360	Screwdriver Shaft, length 80mm	2
217401	Implants Case, 2.4mm (Empty)	1
217410	Drill Bit Φ 1.8mm with Stop, Drilling Depth 12mm	1
217420	Drill Bit Φ 1.8mm with Stop, Drilling Depth 100mm	1
217430	Screwdriver Shaft, Φ 2.4mm, length 80mm	2
217440	Tap, Φ 2.4mm	1
217520	Mesh Plate Cutter	1
216210	3D Mesh Plate Shaper	1
217120	Bending Irons for Reconstruction Plates	2

Please contact your sales representative for final product list.



Instruments

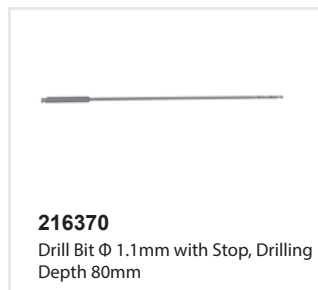
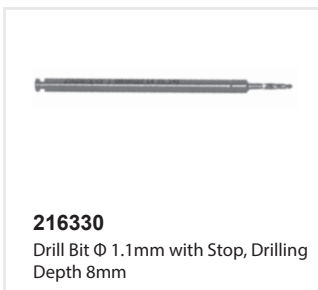
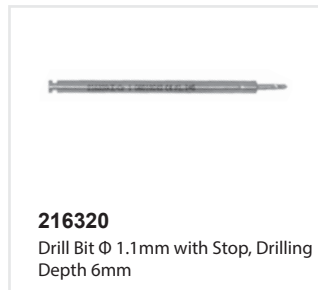
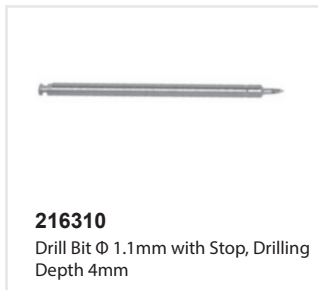
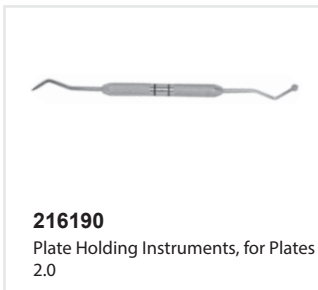
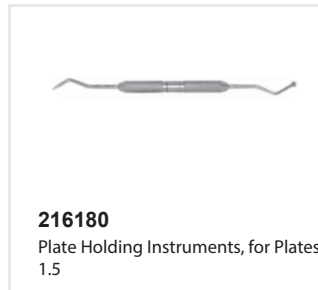
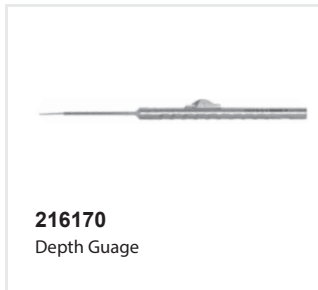
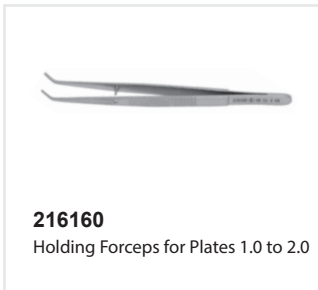
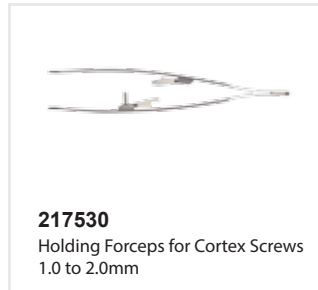
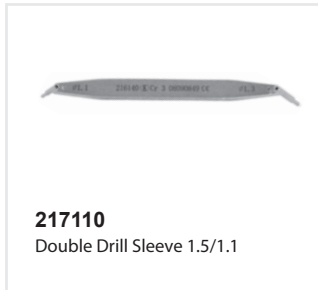
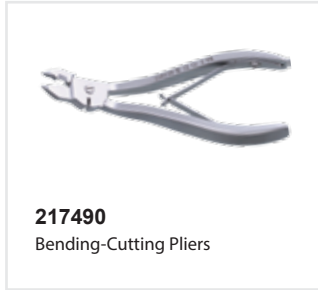
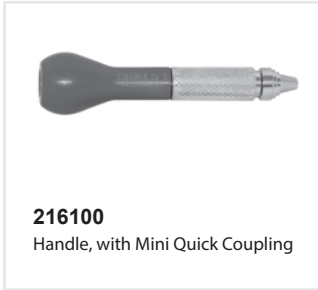

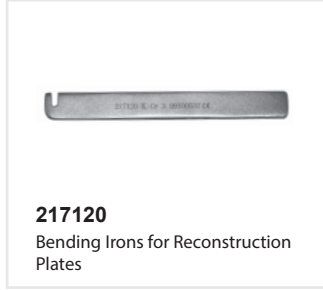
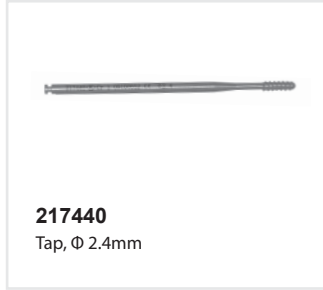
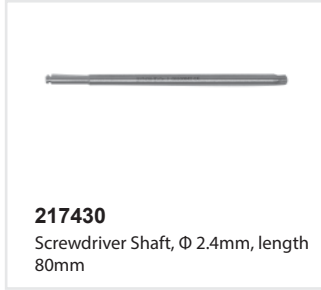
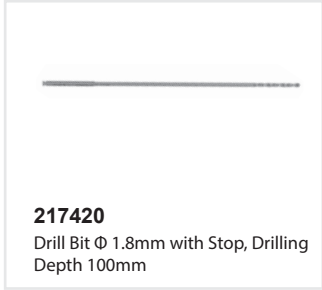
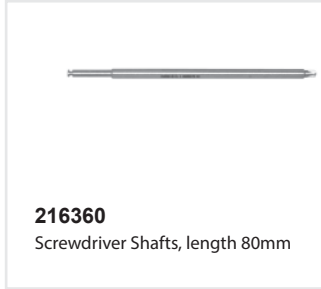
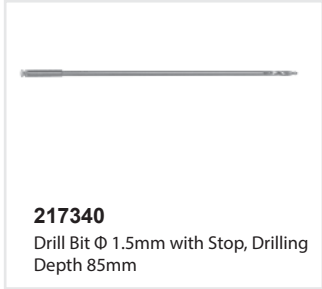
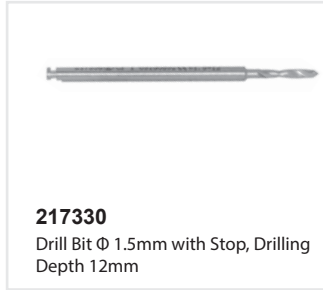
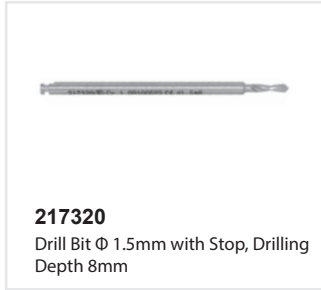
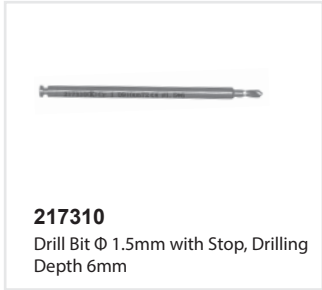

KANGHUI
A Medtronic Company